

HINGE-COVER, SMALL, TYPE 3R

2

INDUSTRY STANDARDS

 UL 50, 50E Listed; Type 3R; File No. E27567
 cUL Listed per CSA C22.2 No 94; Type 3R File No. E27567

 NEMA/EEMAC Type 3R
 IEC 60529, IP32

APPLICATION

These enclosures have a size range of 6 x 4 x 4-in. to 12 x 12 x 10-in. and meet basic functionality requirements for applications that require protection from rain, sleet, snow or dripping water.

FEATURES

- Drip-shield top and seam-free sides, front and back
- Plated steel hinge has stainless steel pin
- Weldnuts provided for mounting optional panels
- Provisions for padlocking on zinc-plated draw-pull catch
- Knockouts on bottom of enclosure
- No gasketing

SPECIFICATIONS

- 16 gauge galvanized steel

FINISH

ANSI 61 gray polyester powder paint finish inside and out over galvanized steel. Optional solid panels are white and optional perforated panels are gray.

ACCESSORIES
See also Accessories.

Industrial Corrosion Inhibitors

Grounding Device

Panels for Type 1 Enclosures and Small Type 3R Enclosures

Touch-Up Paint

BULLETIN: A3SM

Standard Product

Catalog Number	AxBxC in./mm	Panel	Perforated Panel	Panel Size D x E in./mm	Mounting G in./mm	Overall L x W in./mm	Knockout Pattern
A6R44HCR	6.00 x 4.00 x 4.00 152 x 102 x 102	A6N4P	---	4.25 x 2.25 108 x 57	7.00 178	8.00 x 4.81 203 x 122	B-C-D
A6R64HCR	6.00 x 6.00 x 4.00 152 x 152 x 102	A6N6P	A6N6PP	4.25 x 4.25 108 x 108	7.00 178	8.00 x 6.81 203 x 173	B-C-D
A8R64HCR	8.00 x 6.00 x 4.00 203 x 152 x 102	A8N6P	A8N6PP	6.25 x 4.25 159 x 108	9.00 229	10.00 x 6.81 254 x 173	B-C-D
A8R86HCR	8.00 x 8.00 x 6.00 203 x 203 x 152	A8N8P	A8N8PP	6.25 x 6.25 159 x 159	9.00 229	10.00 x 8.81 254 x 224	F-G-H-I
A10R86HCR	10.00 x 8.00 x 6.00 254 x 203 x 152	A10N8P	A10N8PP	8.25 x 6.25 210 x 159	11.00 279	12.00 x 8.81 305 x 224	F-G-H-I
A12R106HCR	12.00 x 10.00 x 6.00 305 x 254 x 152	A12N10P	A12N10PP	10.25 x 8.25 260 x 210	13.00 330	14.00 x 10.81 356 x 275	C-D-E-F-G
A12R126HCR	12.00 x 12.00 x 6.00 305 x 305 x 152	A12N12P	A12N12PP	10.25 x 10.25 260 x 260	13.00 330	14.00 x 12.81 356 x 325	C-D-E-F-G
A12R1210HCR	12.00 x 12.00 x 10.00 305 x 305 x 254	A12N12P	A12N12PP	10.25 x 10.25 260 x 260	13.00 330	14.00 x 12.81 356 x 325	C-D-E-F-G

Purchase panels separately.

Purchase perforated panels separately.

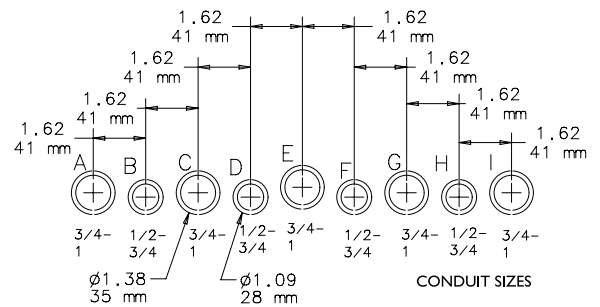
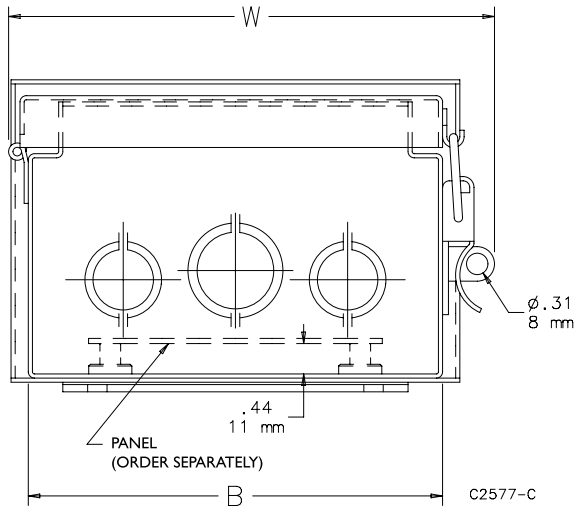
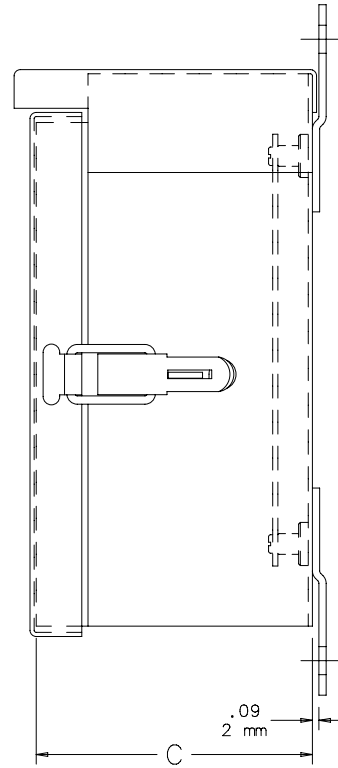
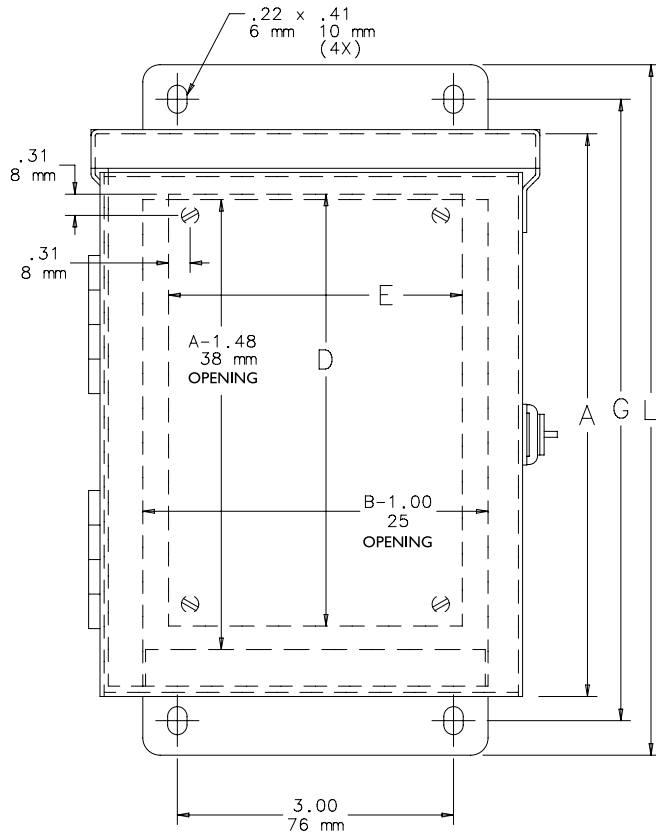

Knockout Pattern
(from outside of box)

NOTE: Refer to table for applicable knockout pattern.

