

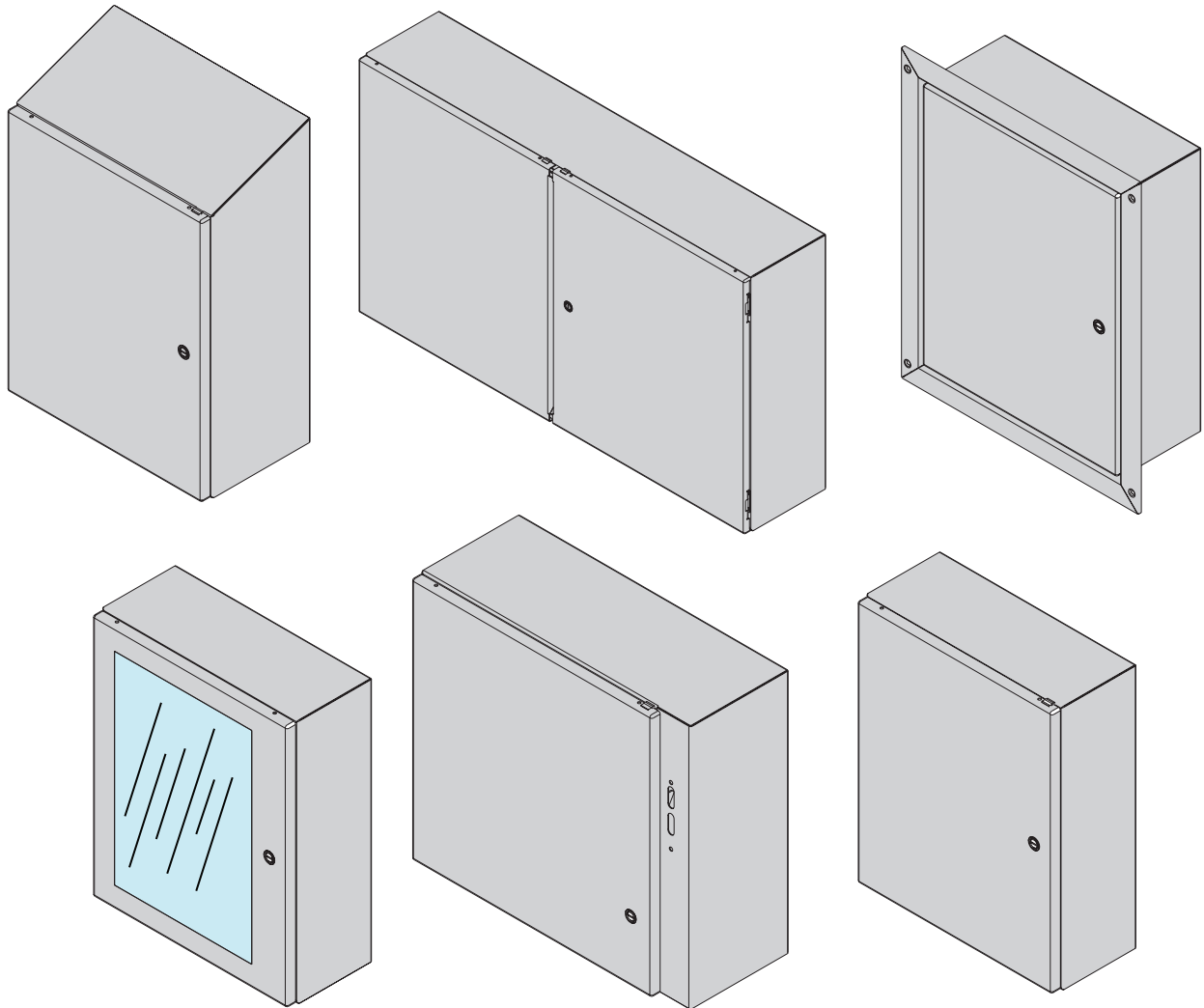

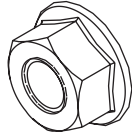



CONCEPT

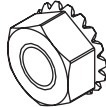
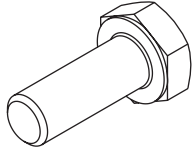

| | | | | | |
|---|---------|---|-----|---|------|
| 1 | M8X1.25 | 2 | 3/8 | 3 | M6X1 |
|  | |  | |  | |
| (4x) (8x) | | (1x) | | (6x) | |
| 4 | M6X1 | 5 | 3/8 | 6 | 3/8 |
|  | |  | |  | |
| (2x) | | (4x) | | (4x) | |
| 7 | | 8 | 1/2 | 9 | |
|  | |  | |  | |
| (2x) | | (4x) | | (0x) | |

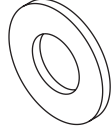
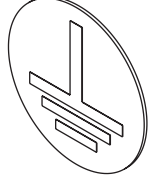
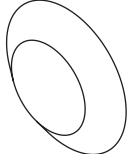