

Integrated signal lamp, continuous light, with integrated LED, blue, 24 V AC/DC, Diameter 70 mm







General technical data	
Product designation	Continuous light element
Consumed current maximum	45 mA
Type of voltage	AC/DC
• of the operating voltage	
Operating voltage	24 V
• 1 at DC rated value	
• 1 at AC at 50 Hz rated value	
• 1 at AC at 60 Hz rated value	24 V
Relative positive tolerance of the operating voltage	10 %
Relative negative tolerance of the operating voltage	-10 %
Reference code	P
• acc. to DIN EN 81346-2	
Mounting type	Bayonet / flush mounting
Material	PC; PC/ABS; PA
Color	blue
Mechanical data	
Product component Light source	Yes

Type of electrical connection	screw-type terminals
Outer diameter of the signal column element	75 mm

Lamp	
Design of the optical signal	continous light
Type of light source	LED
Light intensity	0.22 cd
Light intensity	0.14 ... 0.34 cd
Service life of LED	100 000 h

Ambient conditions	
Ambient temperature during operation	-20 ... +50 °C
Protection class IP	IP65
Depth	31 mm
Height	66 mm
Width	75 mm

Certificates/ approvals

General Product Approval	EMC	Declaration of Conformity	other
 UL		 RCM	 EG-Konf.
		Miscellaneous	Confirmation

Further information

Information- and Downloadcenter (Catalogs, Brochures,...)

www.siemens.com/sirius/catalogs

Industry Mall (Online ordering system)

<https://mall.industry.siemens.com/mall/en/en/Catalog/product?mlfb=8WD5320-5AF>

Cax online generator

<http://support.automation.siemens.com/WW/CAXorder/default.aspx?lang=en&mlfb=8WD5320-5AF>

Service&Support (Manuals, Certificates, Characteristics, FAQs,...)

<https://support.industry.siemens.com/cs/ww/en/ps/8WD5320-5AF>

Image database (product images, 2D dimension drawings, 3D models, device circuit diagrams, EPLAN macros, ...)

http://www.automation.siemens.com/bilddb/cax_de.aspx?mlfb=8WD5320-5AF&lang=en

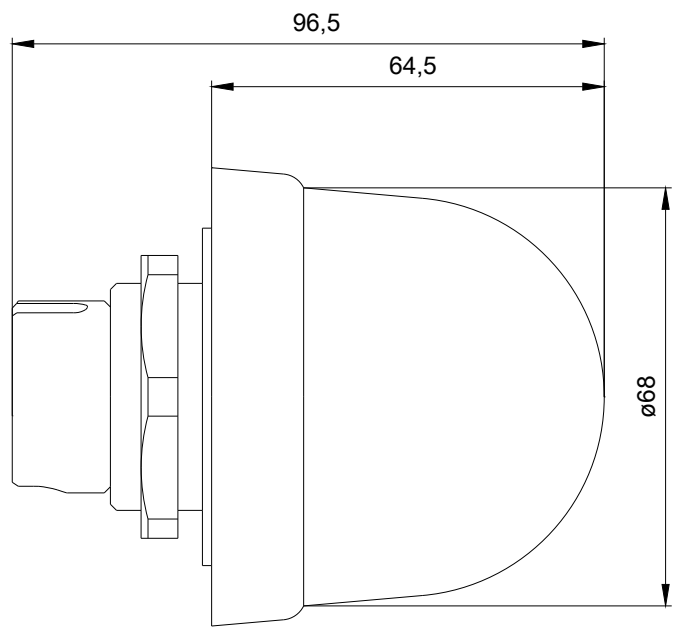
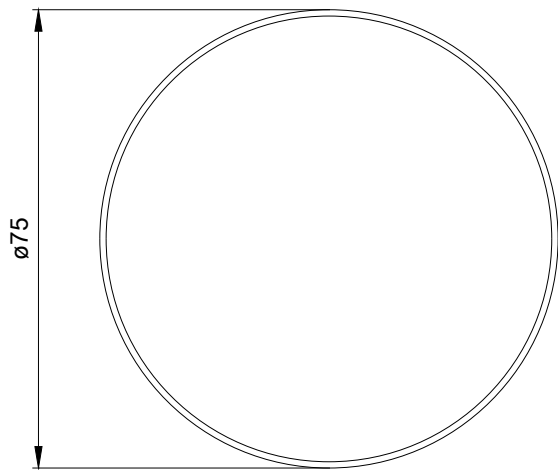

SIEMENS

last modified:

10/07/2019