

FS and FD Cast Hub Device Boxes

UNILETS® for use with Threaded Rigid Conduit and IMC. All Device Boxes have Ridge Top Construction. Furnished with Internal Ground Screw.

NEC/CEC:
Listed for Ordinary Locations

Applications

- Accommodate wiring devices such as switches and receptacles.
- Provide excellent service in areas where boxes are subject to rough usage.
- Serve as pull boxes for conductors.
- Permit access to conductors for maintenance.
- Provide openings for making splices.
- Allow connections for branch conduit runs.
- Blank bodies for special conduit entrance arrangements.

Features

- Corrosion-resistant — ideal for indoor and outdoor installations.
- Weatherproof, raintight and dust-tight when used with cast gasketed covers.
- FS and FD boxes take standard flush wiring devices.
- FD boxes take devices exceeding 41.4 mm (1.63 in) in depth under fastening ears.
- Malleable iron for high tensile strength and ductility — provides greater resistance to impact and shock.
- Both malleable iron and aluminum boxes have ridge top construction for positive cover/gasket/box fit.
- Accurately tapped, tapered threads for tight, rigid joints, ground continuity.
- Complete selection of covers, receptacles, plugs, gaskets and accessories.
- Covers have captive stainless steel screws to speed installation, prevents loss of screws.
- Internal grounding screws standard.
- Available in single, two and three gang and tandem.
- Smooth, rounded integral bushing in each hub protects conductor insulation.

Standard Materials

- Boxes: malleable iron or copperfree (4/10 of 1% max.) aluminum
- Covers: malleable iron, steel, or copperfree (4/10 of 1% max.) aluminum
- Screws: stainless steel
- Gaskets: neoprene

Standard Finishes

- Malleable iron boxes and covers: triple-coat — (1) zinc electroplate, (2) chromate, and (3) epoxy powder coat
- Aluminum boxes and covers: epoxy powder coat
- Steel covers: zinc electroplate

Options

- For additional corrosion protection, specify Hot Dip Galvanized. Add suffix “-G” to catalog number. Contact your local representative for pricing and availability.

NEC/CEC Certifications and Compliances

- UL Standard: 514A
- UL Listed: E-18095, E2527
- CSA Standard: C22.2 No. 18
- CSA Certified: 009795
- Suitable for wet locations when used with gasketed covers.
- Fed Spec: A-A-50563
- NEMA Standard: FB-1



Illustrated Features



Gasket is designed so that it wraps around ridge top of O-Z/Gedney™ aluminum or malleable iron device box. Result is a positive seal against moisture.







Gasket construction. Cover tightens on largest perimeter of gasket and fits snugly against portion of gasket that wraps around ridge top of box.

FS and FD Cast Hub Device Boxes

UNILETS® for use with Threaded Rigid Metal Conduit and IMC. Furnished with Internal Ground Screw.

NEC/CEC:
Listed for Ordinary Locations

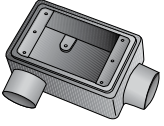
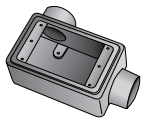
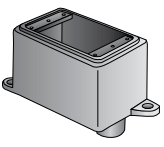
FS Box (Shallow) 2.00" deep, FD Box (Deep) 2.69" deep, ED (Extra Deep) 3.06" deep

| | Type | Depth | Trade Size (Inches) | Catalog Number | |
|---|------|---------|---|--------------------------|--------------------|
| | | | | Malleable Iron Ridge Top | Aluminum Ridge Top |
|  | FS | Shallow | 1/2 | FS-1-50 | FS-1-50-A |
| | | | 3/4 | FS-1-75 | FS-1-75-A |
| | | | 1 | FS-1-100 | FS-1-100-A |
| | FD | Deep | 1/2 | FD-1-50 | FD-1-50-A |
| | | | 1/2 | FD-1-50ED ① | FD-1-50-AED ① |
| | | | 3/4 | FD-1-75 | FD-1-75-A |
| | | | 3/4 | FD-1-75ED ① | FD-1-75-AED ① |
| | | 1 | FD-1-100 | — | |
|  | FSC | Shallow | 1/2 | FSC-1-50 | FSC-1-50-A |
| | | | 3/4 | FSC-1-75 | FSC-1-75-A |
| | | | 1 | FSC-1-100 | — |
| | FDC | Deep | 1/2 | FDC-1-50 | FDC-1-50-A |
| | | | 1/2 | FDC-1-50ED ① | FDC-1-50-AED ① |
| | | | 3/4 | FDC-1-75 | FDC-1-75-A |
| | | | 3/4 | FDC-1-75ED ① | FDC-1-75-AED ① |
| | | 1 | FDC-1-100 | — | |
| | | 1 | FDC-1-100ED ① | FDC-1-100-AED ① | |
|  | FDL | Deep | 1/2 | FDL-1-50 | — |
| | | | 3/4 | FDL-1-75 | — |
| | | | <i>(extra deep without mounting feet)</i> | | |
|  | FDR | Deep | 1/2 | FDR-1-50 | — |
| | | | 3/4 | FDR-1-75 | — |
| | | | <i>(extra deep without mounting feet)</i> | | |
|  | FDA | Deep | 1/2 | FDA-1-50 ① | — |
| | | | 3/4 | FDA-1-75 ① | — |
|  | FSS | Shallow | 1/2 | FSS-1-50 | — |
| | | | 3/4 | FSS-1-75 | FSS-1-75-A |

① Extra deep with mounting feet.
Shaded boxes include mounting feet.

COMMERCIAL AND INDUSTRIAL FITTINGS: CAST DEVICE BOXES



OZGEDNEY

FS and FD Cast Hub Device Boxes

UNILETS® for use with Threaded Rigid Metal Conduit and IMC. FS Box 2.00" Deep, FD Box 2.69" Deep. Furnished with Internal Ground Screw.

NEC/CEC:
Listed for Ordinary Locations

FS Box (Shallow) 2.00" deep, FD Box (Deep) 2.69" deep, ED (Extra Deep) 3.06" deep

| | Type | Depth | Hub Size (Inches) | Catalog Number | |
|---|------|---------|-------------------|--------------------------|--------------------|
| | | | | Malleable Iron Ridge Top | Aluminum Ridge Top |
|  | FSCC | Shallow | 1/2 | FSCC-1-50 | — |
| | | | 3/4 | FSCC-1-75 | FSCC-1-75A |
| | FDCC | Deep | 1/2 | FDCC-1-50 | — |
| | | | 1/2 | FDCC-1-50ED ① | — |
| | | | 3/4 | FDCC-1-75 | — |
| | | | 3/4 | FDCC-1-75ED ① | — |
| | | 1 | FDCC-1-100 | — | |
|  | FSCT | Shallow | 1/2 | FSCT-1-50 | — |
| | | | 3/4 | FSCT-1-75 | — |
| | | | 1 | FSCT-1-100 | — |
| | FDCT | Deep | 1/2 | FDCT-1-50 | — |
| | | | 1/2 | FDCT-1-50ED ① | — |
| | | | 3/4 | FDCT-1-75 | — |
| | | | 3/4 | FDCT-1-75ED ① | — |
| | | | 1 | FDCT-1-100 | — |
| | | 1 | FDCT-1-100ED ① | — | |
|  | FSX | Shallow | 1/2 | FSX-1-50 | — |
| | | | 3/4 | FSX-1-75 | — |
| | FDX | Deep | 1/2 | FDX-1-50 | — |
| | | | 1/2 | FDX-1-50ED ① | — |
| | | | 3/4 | FDX-1-75 | — |
| | | | 3/4 | FDX-1-75ED ① | — |

① Extra deep with mounting feet.

FS and FD Cast Hub Device Boxes

UNILETS® for use with Threaded Rigid Metal Conduit and IMC. FS Box 2.00" Deep, FD Box 2.69" Deep. Furnished with Internal Ground Screw.

NEC/CEC:
Listed for Ordinary Locations

FS Box (Shallow) 2.00" deep, FD Box (Deep) 2.69" deep, ED (Extra Deep) 3.06" deep

| Type | Depth | Hub Size (Inches) | Catalog Number | |
|------|-------|-------------------|--------------------------|--------------------|
| | | | Malleable Iron Ridge Top | Aluminum Ridge Top |

FS Two-Gang Tandem Boxes – Takes single gang covers







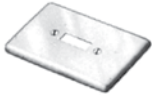

| | | | | |
|----|---------|-----|----------|---|
| FS | Shallow | 3/4 | FS-2T-75 | — |
|----|---------|-----|----------|---|

FS and FD Cast Hub Device Boxes

Steel Covers and Aluminum Covers for Ridge Top Boxes. Furnished with Stainless Steel Screws, Less Gasket.

NEC/CEC:
Listed for Ordinary Locations

| | Description | Catalog Number | |
|---|---|-------------------------------------|-----------------|
| | | Steel | Aluminum |
|  | For square handle tumbler or toggle switches. | FS1-SCS | — |
|  | For round receptacles. Mounts directly on box. Hole Dia. — 1-13/32". | FS1-SRCS | — |
|  | For round receptacles. Mounts directly on box. Hole Dia. — 1-5/8". 3-9/32" C to C screw holes. | FS1-LRCS | — |
|  | For standard 2 or 3 wire duplex receptacles. | FS1-DCS | — |
|  | Blank | FS1-BCS | — |
|  | Blank | FS1-BC <i>(Gray iron)</i> | FS1-BC-A |





COMMERCIAL AND INDUSTRIAL FITTINGS: CAST DEVICE BOXES

OZGEDNEY

FS and FD Cast Hub Device Boxes

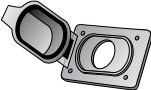
Covers for Ridge Top Boxes.

NEC/CEC:
Listed for Ordinary Locations

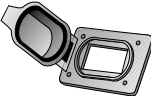
| | Description | Catalog Number | |
|---|--|----------------|-----------|
| | | Malleable Iron | Aluminum |
| Cast Covers NEMA 3R Wet Locations – Furnished with gasket and stainless steel screws | | | |
|  FS1-WRCA | Round receptacle Hole Diameter – 1-7/16" | — | FS1-WRCA |
| | For duplex flush receptacle with spring cover | — | FS1-WDC-A |
|  FS1-WPCA | For external operation of tumbler switches with square handles | — | FS1-WPCA |
|  FS1-WSCA | Operating type for square handle tumbler or toggle switches | — | FS1-WSCA |
| | Rocker type for square handle tumbler or toggle flush switches | — | FSK-1V-A |
| Gasket – Replacement | | | |
|  | Neoprene—for use with wet location covers | | FS1-SG |
| Cast Covers Dry Locations – Furnished with stainless steel screws less gasket | | | |
|  FS1-DC | For standard 2 or 3 wire duplex receptacles | FS1-DC | FS1-DC-A |
|  FS1-GFCA | Ground fault receptacle | — | FS1-GFCA |

COMMERCIAL AND INDUSTRIAL FITTINGS: CAST DEVICE BOXES

OZGEDNEY

FS and FD Cast Hub Device Boxes

NEC/CEC:
Listed for Ordinary Locations

Wiring Capacity

| Hub Size (Inches) | Capacity — dm ³ (in ³) | | |
|-------------------|---|----------------|--------------------|
| | Single-Gang FS | Single-Gang FD | Two-Gang Tandem FS |
| 1/2 | 0.29 (18.00) | 0.41 (25.00) | 0.66 (40.00) |
| 3/4 | 0.29 (18.00) | 0.41 (25.00) | 0.66 (40.00) |
| 1 | 0.29 (18.00) | 0.41 (25.00) | 0.66 (40.00) |

Dimensions in Millimeters (Inches)

FS and FD Single Gang Boxes without lugs

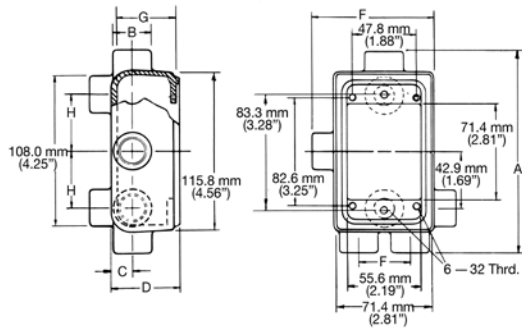

FS Tandem Boxes

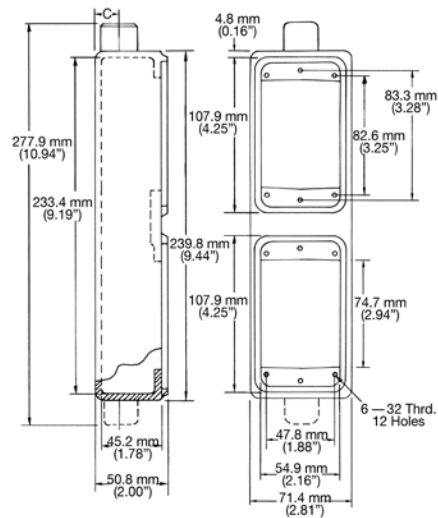

FS and FD Single Gang Boxes with lugs

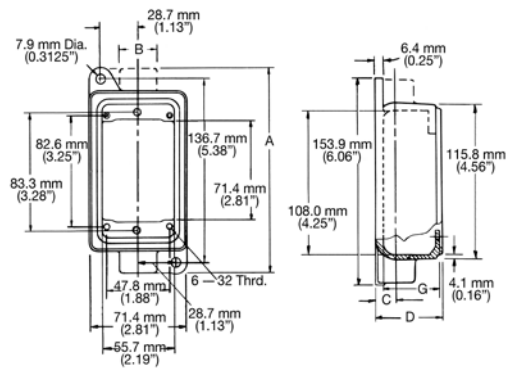

| Hub Size (Inches) | Dimensions in Millimeters (Inches) | | | | | | | | | | |
|-------------------|------------------------------------|-------------|-------------|-------------|-------------|-------------|-------------|-------------|-------------|-------------|---|
| | D | | | | | | | | | | G |
| | A | B | C | "FS" | "FD" | E | F | "FS" | "FD" | H | |
| 1/2 | 149.4 (5.88) | 28.7 (1.13) | 16.0 (0.63) | 50.8 (2.00) | 68.3 (2.69) | 38.1 (1.50) | 88.9 (3.50) | 45.2 (1.78) | 62.0 (2.44) | 42.9 (1.69) | |
| 3/4 | 149.4 (5.88) | 35.1 (1.38) | 19.1 (0.75) | 50.8 (2.00) | 68.3 (2.69) | 52.3 (2.06) | 88.9 (3.50) | 45.2 (1.78) | 62.0 (2.44) | 38.1 (1.50) | |
| 1 | 160.3 (6.31) | 42.9 (1.69) | 23.9 (0.94) | 50.8 (2.00) | 68.3 (2.69) | 52.3 (2.06) | 88.9 (3.50) | 45.2 (1.78) | 62.0 (2.44) | 35.1 (1.38) | |

COMMERCIAL AND INDUSTRIAL FITTINGS: CAST DEVICE BOXES

OZGEDNEY

FS and FD Cast Hub Device Boxes

NEC/CEC:
Listed for Ordinary Locations

Dimensions in Millimeters (Inches)

Type FD Extra Deep

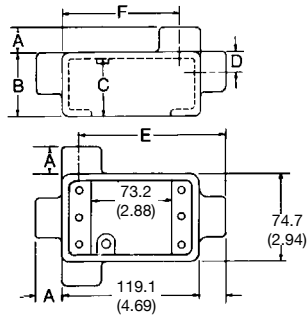

Single Gang

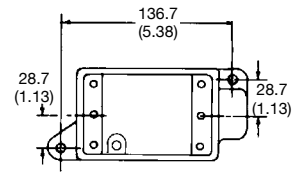
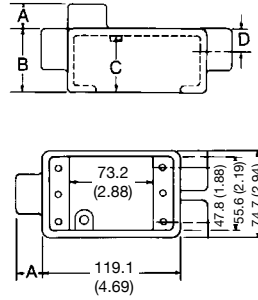

With Mounting Lugs

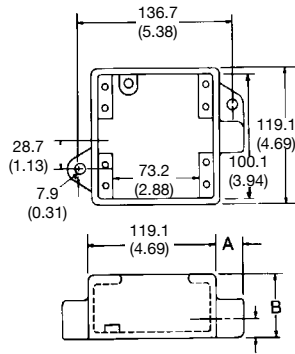

Two Gang
With Mounting Lugs

| Catalog Number | Hub Size (Inches) | Dimensions in Millimeters (Inches) | | | | | |
|-------------------|-------------------|------------------------------------|--------------|--------------|--------------|---------------|---------------|
| | | A | B | C | D | E | F |
| All FD Type Boxes | 1/2 | 19.05 (0.75) | 77.72 (3.06) | 73.15 (2.88) | 16.00 (0.63) | 119.13 (4.69) | 100.08 (3.94) |
| | 3/4 | 19.05 (0.75) | 77.72 (3.06) | 73.15 (2.88) | 19.05 (0.75) | 115.82 (4.56) | 96.77 (3.81) |
| | 1 | 22.35 (0.88) | 77.72 (3.06) | 73.15 (2.88) | 22.35 (0.88) | — | — |

COMMERCIAL AND INDUSTRIAL FITTINGS: CAST DEVICE BOXES



OZGEDNEY

FS and FD Cast Hub Device Boxes

UNILETS® for use with Threaded Rigid Metal Conduit and IMC. Furnished with Internal Ground Screw.

NEC/CEC:
Listed for Ordinary Locations

FS Box (Shallow) 2.00" deep, FD Box (Deep) 2.69" deep, ED (Extra Deep) 3.06" deep

| | Type | Depth | Hub Size (Inches) | Catalog Number | |
|---|------|---------|-------------------|--------------------------|--------------------|
| | | | | Malleable Iron Ridge Top | Aluminum Ridge Top |
|  | FS | Shallow | 1/2 | FS-2-50 | — |
| | | | 3/4 | FS-2-75 | FS-2-75-A |
| | | | 1 | FS-2-100 | — |
| | FD | Deep | 1/2 | FD-2-50 | — |
| | | | 3/4 | FD-2-75 | — |
| | | | 1 | FD-2-100 | — |
|  | FSC | Shallow | 1/2 | FSC-2-50 | — |
| | | | 3/4 | FSC-2-75 | — |
| | | | 1 | FSC-2-100 | — |
| | FDC | Deep | 1/2 | FDC-2-50 | — |
| | | | 3/4 | FDC-2-75 | — |
| | | | 1 | FDC-2-100 | — |







COMMERCIAL AND INDUSTRIAL FITTINGS: CAST DEVICE BOXES

02-GEDNEY

① Largest hub at bottom in illustration.
② Extension does not have a ground screw.

FS and FD Cast Hub Device Boxes

NEC/CEC:
Listed for Ordinary Locations

| | Description | Catalog Number | |
|---|---|--|-----------------|
| | | Steel | Aluminum |
| Stamped Steel and Aluminum Covers — With stainless steel screws, less gasket | | | |
|  | For square handle tumbler or toggle flush switches | FS-2-SCS | — |
|  | For duplex flush receptacles | FS-2-DCS | — |
|  | For tumbler flush switch and duplex flush receptacles | FS-2-SDCS | — |
| | | Malleable Iron | Aluminum |
| Cast Covers — Weatherproof — With gasket and stainless steel screws | | | |
|  | For external operation of tumbler switches with square handles | — | FS-2-WSCA |
|  | Blank Cover | FS-2-BCS <i>FS-2-BC (Gray iron)</i> | FS-2-BCA |
|  | Gasket — Replacement Neoprene — for use with 2-gang cast covers above | FS-2-SG | — |

COMMERCIAL AND INDUSTRIAL FITTINGS: CAST DEVICE BOXES

OZGEDNEY

FS and FD Cast Hub Device Boxes

NEC/CEC:
Listed for Ordinary Locations

Wiring Capacity

| Hub Size (Inches) | Capacity — dm ³ (in ³) | |
|-------------------|---|--------------|
| | FS | FD |
| 1/2 | 0.52 (32.00) | 0.74 (45.00) |
| 3/4 | 0.52 (32.00) | 0.74 (45.00) |
| 1 | 0.52 (32.00) | 0.74 (45.00) |

Dimensions in Millimeters (Inches)

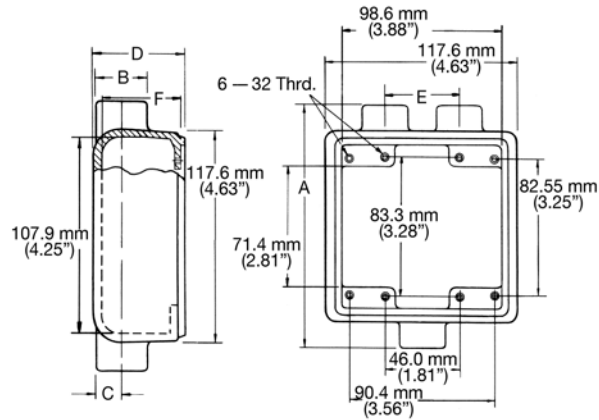

| Hub Size (Inches) | Dimensions in Millimeters (Inches) | | | | | | | |
|-------------------|------------------------------------|-------------|-------------|-------------|-------------|-------------|-------------|-------------|
| | A | B | C | D | | E | F | |
| | | | | "FS" | "FD" | | "FS" | "FD" |
| 1/2 | 149.4 (5.88) | 28.7 (1.13) | 16.0 (0.63) | 50.8 (2.00) | 68.3 (2.69) | 47.8 (1.88) | 45.2 (1.78) | 62.0 (2.44) |
| 3/4 | 149.4 (5.88) | 35.1 (1.38) | 19.1 (0.75) | 50.8 (2.00) | 68.3 (2.69) | 47.8 (1.88) | 45.2 (1.78) | 62.0 (2.44) |
| 1 | 160.3 (6.31) | 42.9 (1.69) | 23.9 (0.94) | 50.8 (2.00) | 68.3 (2.69) | 52.3 (2.06) | 45.2 (1.78) | 62.0 (2.44) |

COMMERCIAL AND INDUSTRIAL FITTINGS: CAST DEVICE BOXES

OZGEDNEY