

Reversing contactor assembly AC-3, 3 kW/400 V, 48 V DC 3-pole,
Size S00 screw terminal electrical and mechanical interlock



Product brand name	SIRIUS
Product designation	Reversing contactor assembly
Product type designation	3RA23
Manufacturer's article number	<ul style="list-style-type: none"> • 1 of the supplied contactor 3RT2015-1BW42 • 2 of the supplied contactor 3RT2015-1BW42 • of the supplied RH assembly kit 3RA2913-2AA1

General technical data	
Size of contactor	S00
Product extension	Yes
<ul style="list-style-type: none"> • Auxiliary switch 	
Insulation voltage	690 V
<ul style="list-style-type: none"> • with degree of pollution 3 rated value 	
Degree of pollution	3
Surge voltage resistance rated value	6 kV
Protection class IP	IP20
<ul style="list-style-type: none"> • on the front 	
Shock resistance	9.8g / 5 ms and 5.9g / 10 ms
Shock resistance at rectangular impulse	

<ul style="list-style-type: none"> • at AC • at DC 	6,7g / 5 ms, 4,2g / 10 ms 6,7g / 5 ms, 4,2g / 10 ms
Shock resistance with sine pulse <ul style="list-style-type: none"> • at AC • at DC 	10,5g / 5 ms, 6,6g / 10 ms 10,5g / 5 ms, 6,6g / 10 ms
Mechanical service life (switching cycles) <ul style="list-style-type: none"> • of contactor typical • of the contactor with added auxiliary switch block typical 	10 000 000 10 000 000
Reference code acc. to DIN EN 81346-2	Q

Ambient conditions

Installation altitude at height above sea level <ul style="list-style-type: none"> • maximum 	2 000 m
Ambient temperature <ul style="list-style-type: none"> • during operation • during storage 	-25 ... +60 °C -55 ... +80 °C

Main circuit

Number of poles for main current circuit	3
Number of NO contacts for main contacts	3
Number of NC contacts for main contacts	0
Operating voltage <ul style="list-style-type: none"> • at AC-3 rated value maximum 	690 V
Operating current <ul style="list-style-type: none"> • at AC-1 at 400 V <ul style="list-style-type: none"> — at ambient temperature 40 °C rated value — at ambient temperature 60 °C rated value • at AC-2 at 400 V rated value • at AC-3 <ul style="list-style-type: none"> — at 400 V rated value 	18 A 16 A 7 A 7 A
Operating current <ul style="list-style-type: none"> • at 1 current path at DC-1 <ul style="list-style-type: none"> — at 24 V rated value — at 110 V rated value • with 2 current paths in series at DC-1 <ul style="list-style-type: none"> — at 24 V rated value — at 110 V rated value • with 3 current paths in series at DC-1 <ul style="list-style-type: none"> — at 24 V rated value — at 110 V rated value 	15 A 1.5 A 15 A 8.4 A 15 A 15 A
Operating current <ul style="list-style-type: none"> • at 1 current path at DC-3 at DC-5 	

— at 24 V rated value	15 A
— at 110 V rated value	0.1 A
• with 2 current paths in series at DC-3 at DC-5	
— at 24 V rated value	15 A
— at 110 V rated value	0.25 A
• with 3 current paths in series at DC-3 at DC-5	
— at 24 V rated value	15 A
— at 110 V rated value	15 A
Operating power	
• at AC-2 at 400 V rated value	3 kW
• at AC-3	
— at 400 V rated value	3 kW
— at 500 V rated value	3.5 kW
— at 690 V rated value	4 kW
• at AC-4 at 400 V rated value	3 kW
No-load switching frequency	1 500 1/h
Operating frequency	
• at AC-1 maximum	1 000 1/h
• at AC-2 maximum	750 1/h
• at AC-3 maximum	750 1/h
• at AC-4 maximum	250 1/h
Control circuit/ Control	
Type of voltage of the control supply voltage	DC
Control supply voltage 1	
• at DC rated value	48 V
Closing power of magnet coil at DC	4 W
Holding power of magnet coil at DC	4 W
Auxiliary circuit	
Operating current of auxiliary contacts at AC-12 maximum	10 A
Operating current of auxiliary contacts at AC-15	
• at 230 V	6 A
• at 400 V	3 A
Operating current of auxiliary contacts at DC-13	
• at 24 V	10 A
• at 60 V	2 A
• at 110 V	1 A
• at 220 V	0.3 A
Contact reliability of auxiliary contacts	< 1 error per 100 million operating cycles
UL/CSA ratings	
Full-load current (FLA) for three-phase AC motor	

<ul style="list-style-type: none"> • at 480 V rated value • at 600 V rated value 	<p>4.8 A</p> <p>6.1 A</p>
Yielded mechanical performance [hp] <ul style="list-style-type: none"> • for single-phase AC motor <ul style="list-style-type: none"> — at 110/120 V rated value — at 230 V rated value • for three-phase AC motor <ul style="list-style-type: none"> — at 200/208 V rated value — at 220/230 V rated value — at 460/480 V rated value — at 575/600 V rated value 	<p>0.25 hp</p> <p>0.75 hp</p> <p>1.5 hp</p> <p>2 hp</p> <p>3 hp</p> <p>5 hp</p>
Contact rating of auxiliary contacts according to UL	<p>A600 / Q600</p>

Short-circuit protection

Design of the fuse link <ul style="list-style-type: none"> • for short-circuit protection of the main circuit <ul style="list-style-type: none"> — with type of coordination 1 required — with type of assignment 2 required • for short-circuit protection of the auxiliary switch required 	<p>gG NH 3NA, DIAZED 5SB, NEOZED 5SE: 35 A</p> <p>gG NH 3NA, DIAZED 5SB, NEOZED 5SE: 20 A</p> <p>fuse gG: 10 A</p>
------------------------------------------------------------------------------------------------------------------------------------------------------------------------------------------------------------------------------------------------------------------------------------------------------------------------------------------------------	--------------------------------------------------------------------------------------------------------------------

Installation/ mounting/ dimensions

Mounting position	<p>+/-180° rotation possible on vertical mounting surface; can be tilted forward and backward by +/- 22.5° on vertical mounting surface</p>
Mounting type	<p>screw and snap-on mounting onto 35 mm standard mounting rail</p>
Height	<p>68 mm</p>
Width	<p>90 mm</p>
Depth	<p>73 mm</p>
Required spacing <ul style="list-style-type: none"> • with side-by-side mounting <ul style="list-style-type: none"> — forwards — Backwards — upwards — downwards — at the side • for grounded parts <ul style="list-style-type: none"> — forwards — Backwards — upwards — at the side — downwards • for live parts 	<p>6 mm</p> <p>0 mm</p> <p>6 mm</p> <p>6 mm</p> <p>6 mm</p> <p>6 mm</p> <p>6 mm</p> <p>0 mm</p> <p>6 mm</p> <p>6 mm</p> <p>6 mm</p>

— forwards	6 mm
— Backwards	0 mm
— upwards	6 mm
— downwards	6 mm
— at the side	6 mm

Connections/ Terminals

Type of electrical connection	
• for main current circuit	screw-type terminals
• for auxiliary and control current circuit	screw-type terminals
Type of connectable conductor cross-sections	
• for main contacts	
— solid	2x (0.5 ... 1.5 mm ²), 2x (0.75 ... 2.5 mm ²), 2x 4 mm ²
— single or multi-stranded	2x (0,5 ... 1,5 mm ²), 2x (0,75 ... 2,5 mm ²), 2x (0,5 ... 4 mm ²)
— finely stranded with core end processing	2x (0.5 ... 1.5 mm ²), 2x (0.75 ... 2.5 mm ²)
• at AWG conductors for main contacts	2x (20 ... 16), 2x (18 ... 14)
Type of connectable conductor cross-sections	
• for auxiliary contacts	
— single or multi-stranded	2x (0,5 ... 1,5 mm ²), 2x (0,75 ... 2,5 mm ²)
— finely stranded with core end processing	2x (0.5 ... 1.5 mm ²), 2x (0.75 ... 2.5 mm ²)
• at AWG conductors for auxiliary contacts	2x (20 ... 16), 2x (18 ... 14)





Safety related data

B10 value	
• with high demand rate acc. to SN 31920	1 000 000
Proportion of dangerous failures	
• with low demand rate acc. to SN 31920	40 %
• with high demand rate acc. to SN 31920	75 %
Failure rate [FIT]	
• with low demand rate acc. to SN 31920	100 FIT
T1 value for proof test interval or service life acc. to IEC 61508	20 y



Communication/ Protocol

Product function Bus communication	No
Protocol is supported	
• AS-Interface protocol	No
Product function Control circuit interface with IO link	No

Certificates/ approvals

General Product Approval			Declaration of Conformity	Test Certificates
 CSA	 UL		 EG-Konf.	Miscellaneous Special Test Certificate

Test Certificates	Marine / Shipping				
Type Test Certificates/Test Report	 ABS	 BUREAU VERITAS	 LRS	 PRS	 RINA

Marine / Shipping	other	Railway
 RMRS	 DNV-GL DNVGL.COM/AF	Confirmation Vibration and Shock

Further information

Information- and Downloadcenter (Catalogs, Brochures,...)

www.siemens.com/sirius/catalogs

Industry Mall (Online ordering system)

<https://mall.industry.siemens.com/mall/en/en/Catalog/product?mlfb=3RA2315-8XB30-1BW4>

Cax online generator

<http://support.automation.siemens.com/WW/CAXorder/default.aspx?lang=en&mlfb=3RA2315-8XB30-1BW4>

Service&Support (Manuals, Certificates, Characteristics, FAQs,...)

<https://support.industry.siemens.com/cs/ww/en/ps/3RA2315-8XB30-1BW4>

Image database (product images, 2D dimension drawings, 3D models, device circuit diagrams, EPLAN macros, ...)

http://www.automation.siemens.com/bilddb/cax_de.aspx?mlfb=3RA2315-8XB30-1BW4&lang=en

Characteristic: Tripping characteristics, I_t, Let-through current

<https://support.industry.siemens.com/cs/ww/en/ps/3RA2315-8XB30-1BW4/char>

Further characteristics (e.g. electrical endurance, switching frequency)

<http://www.automation.siemens.com/bilddb/index.aspx?view=Search&mlfb=3RA2315-8XB30-1BW4&objecttype=14&gridview=view1>

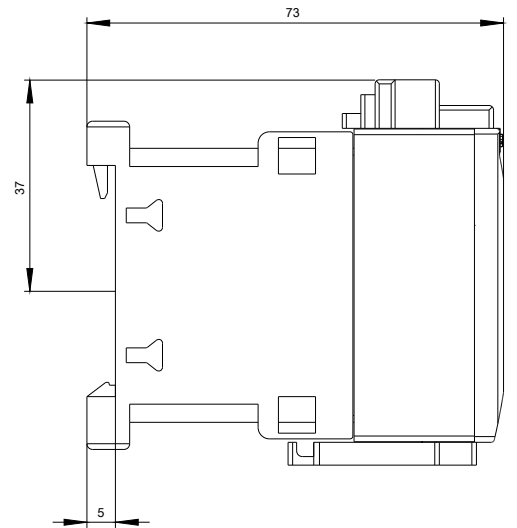
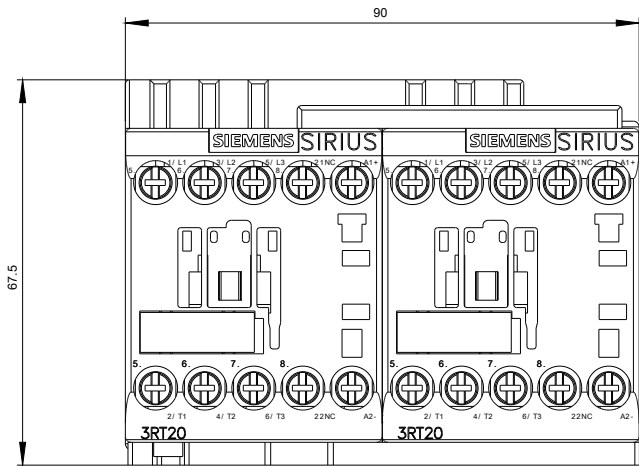

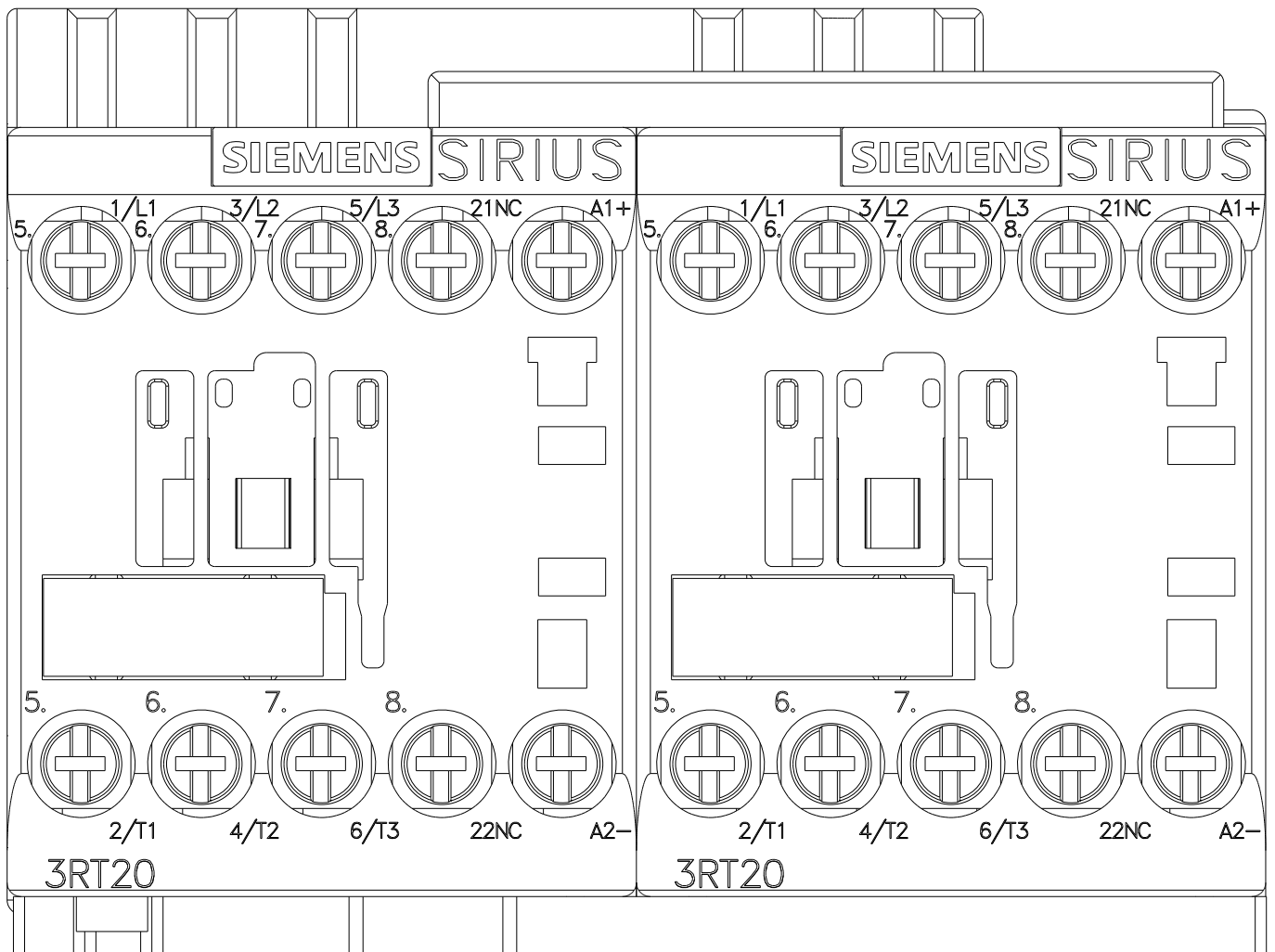

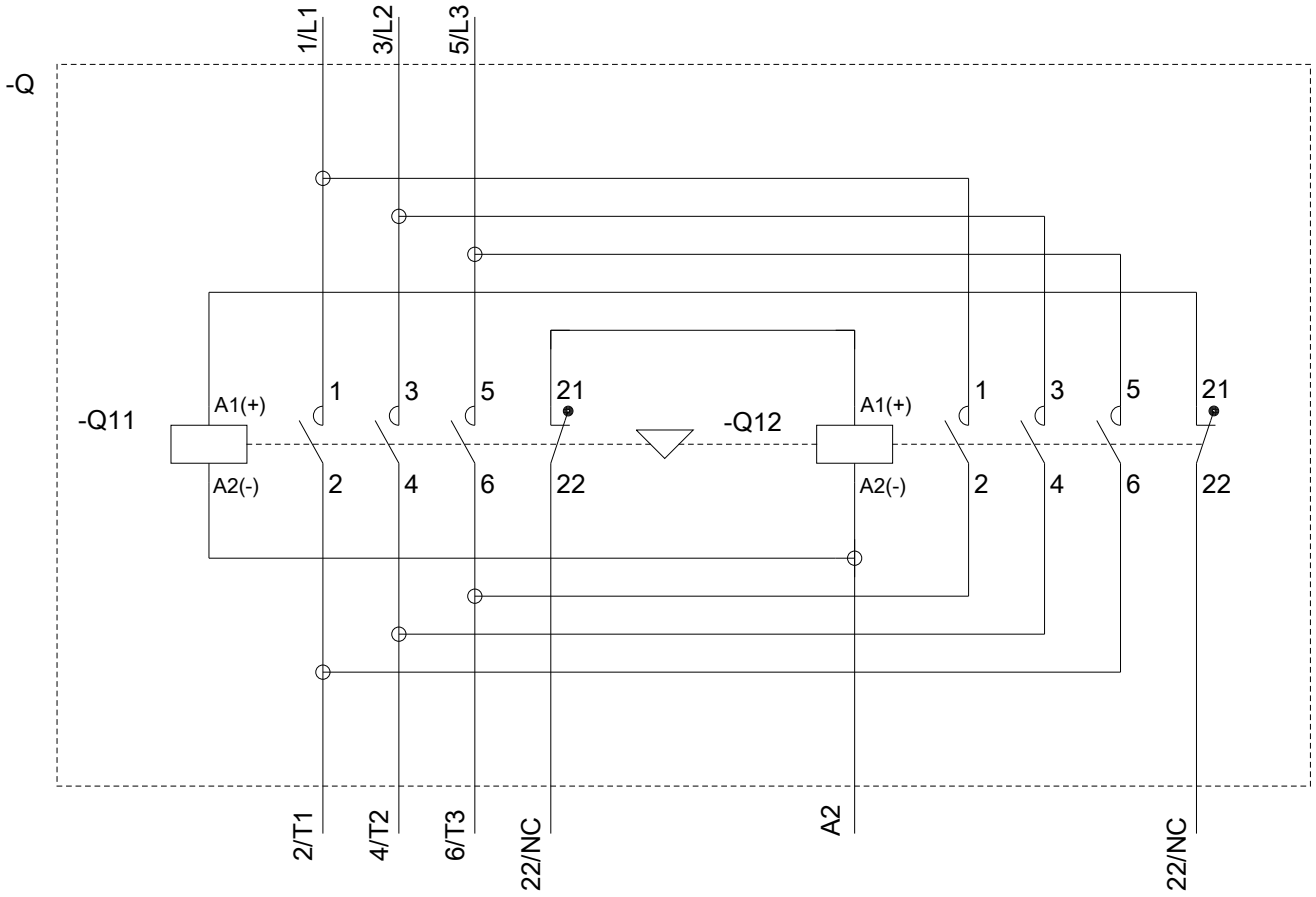

last modified:

11/19/2019