

Auxiliary switch lateral, 2 NO Current path 1 NO, 1 NO for 3RH and 3RT screw terminal R: 23/24, 33/34 L: 43/44, 53/54



General technical data	
Product brand name	SIRIUS
Suitability for use	Contact relay and power contactor
Protection class IP on the front	IP20
Ambient temperature	
<ul style="list-style-type: none"> <li>during storage</li> <li>during operation</li> </ul>	-55 ... +80 °C -25 ... +60 °C
Mechanical service life (switching cycles) typical	10 000 000
Electrical endurance (switching cycles) at AC-15 at 230 V typical	200 000
Contact reliability	one incorrect switching operation of 100 million switching operations (17 V, 1 mA)
Contact reliability of auxiliary contacts	1 faulty switching per 100 million (17 V, 1 mA)
Insulation voltage with degree of pollution 3 rated value	690 V
Surge voltage resistance rated value	6 kV
Auxiliary circuit	
Number of NC contacts for auxiliary contacts	
<ul style="list-style-type: none"> <li>instantaneous contact</li> </ul>	0

<ul style="list-style-type: none"> <li>• lagging switching</li> </ul>	0
<b>Number of NO contacts for auxiliary contacts</b>	
<ul style="list-style-type: none"> <li>• instantaneous contact</li> </ul>	2
<ul style="list-style-type: none"> <li>• leading contact</li> </ul>	0
<b>Operating current of auxiliary contacts at AC-12</b>	
<ul style="list-style-type: none"> <li>• at 24 V</li> </ul>	10 A
<ul style="list-style-type: none"> <li>• at 230 V</li> </ul>	10 A
<ul style="list-style-type: none"> <li>• maximum</li> </ul>	10 A
<b>Operating current</b>	
<ul style="list-style-type: none"> <li>• of auxiliary contacts <ul style="list-style-type: none"> <li>— at AC-14 <ul style="list-style-type: none"> <li>— at 125 V</li> <li>— at 250 V</li> </ul> </li> <li>— at AC-15 <ul style="list-style-type: none"> <li>— at 24 V</li> <li>— at 230 V</li> <li>— at 400 V</li> </ul> </li> </ul> </li> <li>• at AC-15 at 690 V rated value</li> </ul>	6 A 6 A 6 A 6 A 3 A 1 A
<b>Operating current</b>	
<ul style="list-style-type: none"> <li>• of auxiliary contacts at DC-12 <ul style="list-style-type: none"> <li>— at 24 V</li> <li>— at 110 V</li> <li>— at 220 V</li> </ul> </li> <li>• with 2 current paths in series at DC-12 <ul style="list-style-type: none"> <li>— at 24 V rated value</li> <li>— at 60 V rated value</li> <li>— at 110 V rated value</li> <li>— at 220 V rated value</li> <li>— at 440 V rated value</li> <li>— at 600 V rated value</li> </ul> </li> <li>• with 3 current paths in series at DC-12 <ul style="list-style-type: none"> <li>— at 24 V rated value</li> <li>— at 60 V rated value</li> <li>— at 110 V rated value</li> <li>— at 220 V rated value</li> <li>— at 440 V rated value</li> <li>— at 600 V rated value</li> </ul> </li> </ul>	10 A 3 A 1 A 10 A 10 A 4 A 2 A 1.3 A 0.65 A 10 A 10 A 10 A 3.6 A 2.5 A 1.8 A
<b>Operating current</b>	
<ul style="list-style-type: none"> <li>• of auxiliary contacts at DC-13 <ul style="list-style-type: none"> <li>— at 24 V</li> <li>— at 60 V</li> </ul> </li> </ul>	6 A 2 A

— at 110 V	1 A
— at 220 V	0.3 A
• with 2 current paths in series at DC-13	
— at 24 V rated value	10 A
— at 60 V rated value	3.5 A
— at 110 V rated value	1.3 A
— at 220 V rated value	0.9 A
— at 440 V rated value	0.2 A
— at 600 V rated value	0.1 A
• with 3 current paths in series at DC-13	
— at 24 V rated value	10 A
— at 60 V rated value	4.7 A
— at 110 V rated value	3 A
— at 220 V rated value	1.2 A
— at 440 V rated value	0.5 A
— at 600 V rated value	0.26 A

#### Installation/ mounting/ dimensions

<b>Mounting type</b>	snap-on mounting
<b>Width</b>	10 mm
<b>Height</b>	57.4 mm
<b>Depth</b>	66 mm

#### Connections/Terminals



<b>Type of electrical connection for auxiliary and control current circuit</b>	screw-type terminals
<b>Type of connectable conductor cross-sections</b>	
• for auxiliary contacts	
— finely stranded	
— with core end processing	2x (0.5 ... 1.5 mm <sup>2</sup> ), 2x (0.75 ... 2.5 mm <sup>2</sup> )
• at AWG conductors for auxiliary contacts	2x (20 ... 16), 2x (18 ... 14)



#### Safety related data

<b>Product function Mirror contact acc. to IEC 60947-4-1</b>	Yes
• <b>Note</b>	with 3RT2
<b>Product function positively driven operation acc. to IEC 60947-5-1</b>	No

#### Certificates/approvals

General Product Approval				Declaration of Conformity	Test Certificates
 CCC	 CSA	 UL		 EG-Konf.	<a href="#">Special Test Certificate</a>

Test Certificates	Shipping Approval				
<a href="#">Type Test Certificates/Test Report</a>	 ABS	 BUREAU VERITAS	 LRS	 PRS	 RINA

Shipping Approval	other	Railway
 RMRS	<a href="#">Confirmation</a>	<a href="#">Vibration and Shock</a>
	 VDE	

Further information

- Information- and Downloadcenter (Catalogs, Brochures,...)**  
<http://www.siemens.com/industrial-controls/catalogs>
- Industry Mall (Online ordering system)**  
<https://mall.industry.siemens.com/mall/en/en/Catalog/product?mlfb=3RH2911-1DA20>
- Cax online generator**  
<http://support.automation.siemens.com/WW/CAXorder/default.aspx?lang=en&mlfb=3RH2911-1DA20>
- Service&Support (Manuals, Certificates, Characteristics, FAQs,...)**  
<https://support.industry.siemens.com/cs/ww/en/ps/3RH2911-1DA20>
- Image database (product images, 2D dimension drawings, 3D models, device circuit diagrams, EPLAN macros, ...)**  
[http://www.automation.siemens.com/bilddb/cax\\_de.aspx?mlfb=3RH2911-1DA20&lang=en](http://www.automation.siemens.com/bilddb/cax_de.aspx?mlfb=3RH2911-1DA20&lang=en)

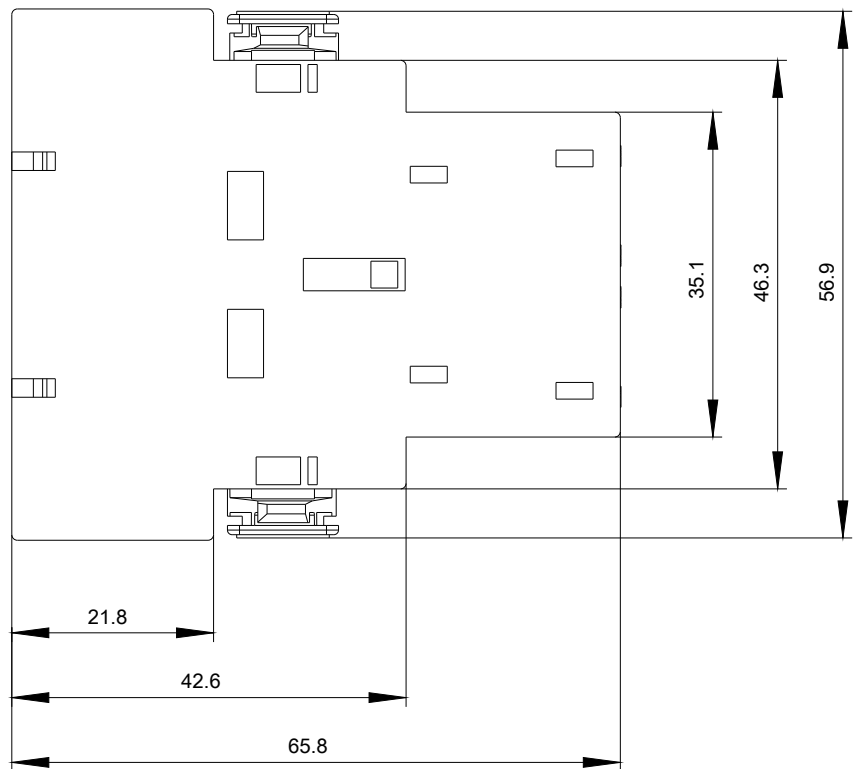
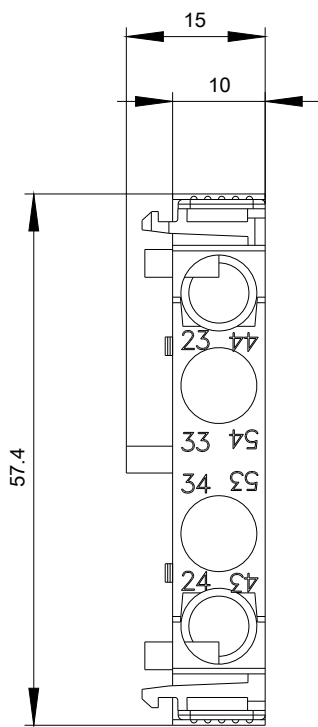

links

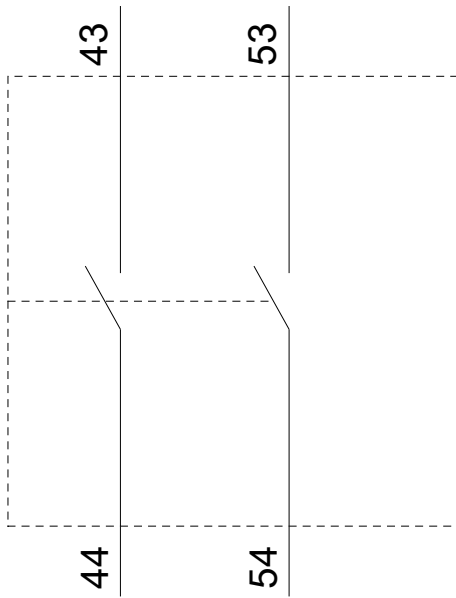

rechts

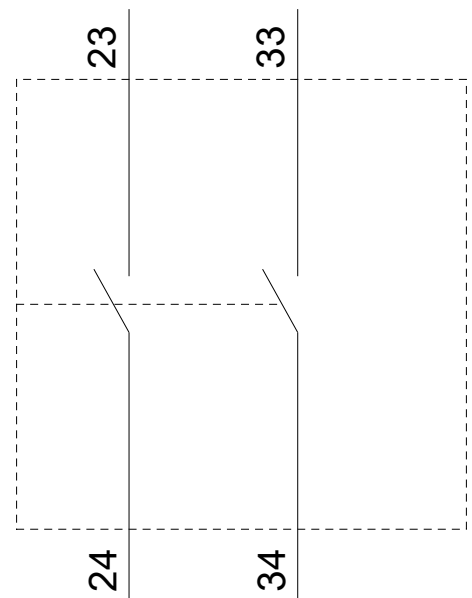

last modified:

01/11/2019