

SIEMENS

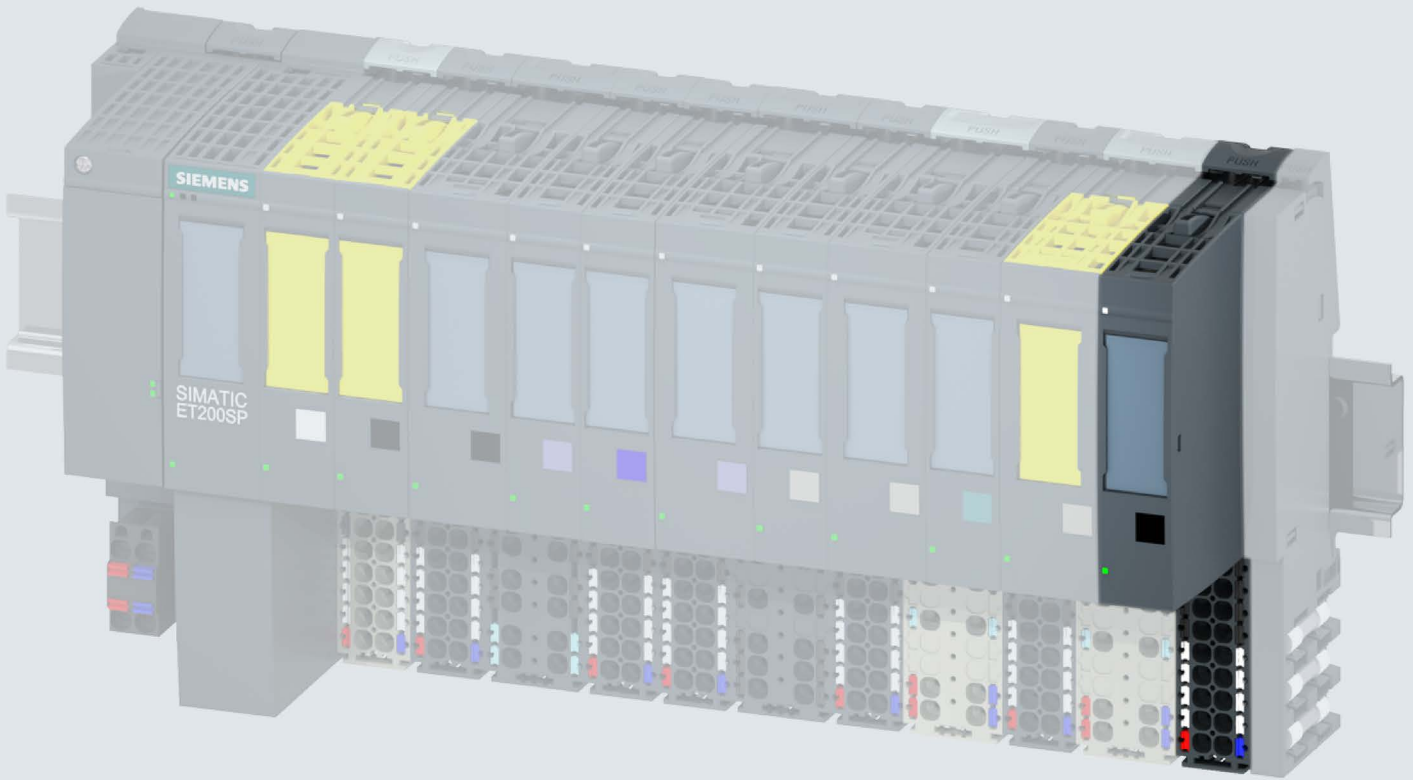

Manual

SIMATIC

ET 200SP

Digital output module
DQ 8x24VDC/0.5A BA (6ES7132-6BF01-0AA0)

Edition

09/2017

support.industry.siemens.com

SIEMENS

SIMATIC

ET 200SP

Digital output module
DQ 8x24VDC/0.5A BA
(6ES7132-6BF01-0AA0)

Manual

Preface

Documentation guide

1

Product overview

2

Wiring

3

Parameters/address space

4

Interrupts/diagnostics alarms

5

Technical specifications

6



Parameter data record

A

Legal information

Warning notice system

This manual contains notices you have to observe in order to ensure your personal safety, as well as to prevent damage to property. The notices referring to your personal safety are highlighted in the manual by a safety alert symbol, notices referring only to property damage have no safety alert symbol. These notices shown below are graded according to the degree of danger.

 DANGER
indicates that death or severe personal injury will result if proper precautions are not taken.
 WARNING
indicates that death or severe personal injury may result if proper precautions are not taken.
 CAUTION
indicates that minor personal injury can result if proper precautions are not taken.
NOTICE
indicates that property damage can result if proper precautions are not taken.

If more than one degree of danger is present, the warning notice representing the highest degree of danger will be used. A notice warning of injury to persons with a safety alert symbol may also include a warning relating to property damage.

Qualified Personnel

The product/system described in this documentation may be operated only by **personnel qualified** for the specific task in accordance with the relevant documentation, in particular its warning notices and safety instructions. Qualified personnel are those who, based on their training and experience, are capable of identifying risks and avoiding potential hazards when working with these products/systems.

Proper use of Siemens products

Note the following:

 WARNING
Siemens products may only be used for the applications described in the catalog and in the relevant technical documentation. If products and components from other manufacturers are used, these must be recommended or approved by Siemens. Proper transport, storage, installation, assembly, commissioning, operation and maintenance are required to ensure that the products operate safely and without any problems. The permissible ambient conditions must be complied with. The information in the relevant documentation must be observed.

Trademarks

All names identified by ® are registered trademarks of Siemens AG. The remaining trademarks in this publication may be trademarks whose use by third parties for their own purposes could violate the rights of the owner.

Disclaimer of Liability

We have reviewed the contents of this publication to ensure consistency with the hardware and software described. Since variance cannot be precluded entirely, we cannot guarantee full consistency. However, the information in this publication is reviewed regularly and any necessary corrections are included in subsequent editions.

Preface

Purpose of the documentation

This manual supplements the system manual ET 200SP distributed I/O system (<http://support.automation.siemens.com/WW/view/en/58649293>).

Functions that generally relate to the system are described in this manual.

The information provided in this manual and in the system/function manuals supports you in commissioning the system.

Changes compared to previous version

Compared to the previous version, this manual contains the following change:

Due to the change in hardware, the article number of the module has been changed from 6ES7132-6BF00-0AA0 to 6ES7132-6BF01-0AA0. Both modules are compatible, except for the firmware-update function.

Conventions

CPU: When the term "CPU" is used in this manual, it applies to the CPUs of the S7-1500 automation system as well as to the CPUs/interface modules of the distributed I/O system ET 200SP.

STEP 7: In this documentation, "STEP 7" is used as a synonym for all versions of the configuration and programming software "STEP 7 (TIA Portal)".

Please also observe notes marked as follows:

Note

A note contains important information on the product described in the documentation, on the handling of the product or on the section of the documentation to which particular attention should be paid.

Security information

Siemens provides products and solutions with industrial security functions that support the secure operation of plants, systems, machines and networks.

In order to protect plants, systems, machines and networks against cyber threats, it is necessary to implement – and continuously maintain – a holistic, state-of-the-art industrial security concept. Siemens' products and solutions constitute one element of such a concept.

Customers are responsible for preventing unauthorized access to their plants, systems, machines and networks. Such systems, machines and components should only be connected to an enterprise network or the internet if and to the extent such a connection is necessary and only when appropriate security measures (e.g. firewalls and/or network segmentation) are in place.

For additional information on industrial security measures that may be implemented, please visit (<http://www.siemens.com/industrialsecurity>).

Siemens' products and solutions undergo continuous development to make them more secure. Siemens strongly recommends that product updates are applied as soon as they are available and that the latest product versions are used. Use of product versions that are no longer supported, and failure to apply the latest updates may increase customers' exposure to cyber threats.

To stay informed about product updates, subscribe to the Siemens Industrial Security RSS Feed under (<http://www.siemens.com/industrialsecurity>).

Table of contents

	Preface	4
1	Documentation guide	7
2	Product overview	12
	2.1 Properties	12
3	Wiring	14
	3.1 Wiring and block diagram	14
4	Parameters/address space	17
	4.1 Parameters	17
	4.2 Explanation of the parameters	19
	4.3 Address space	20
5	Interrupts/diagnostics alarms	21
	5.1 Status and error display	21
	5.2 Interrupts	23
	5.3 Diagnostics alarms	23
6	Technical specifications	24
	6.1 Technical specifications	24
A	Parameter data record	29
	A.1 Parameter assignment and structure of the parameter data record	29

Documentation guide

The documentation for the SIMATIC ET 200SP distributed I/O system is arranged into three areas.

This arrangement enables you to access the specific content you require.

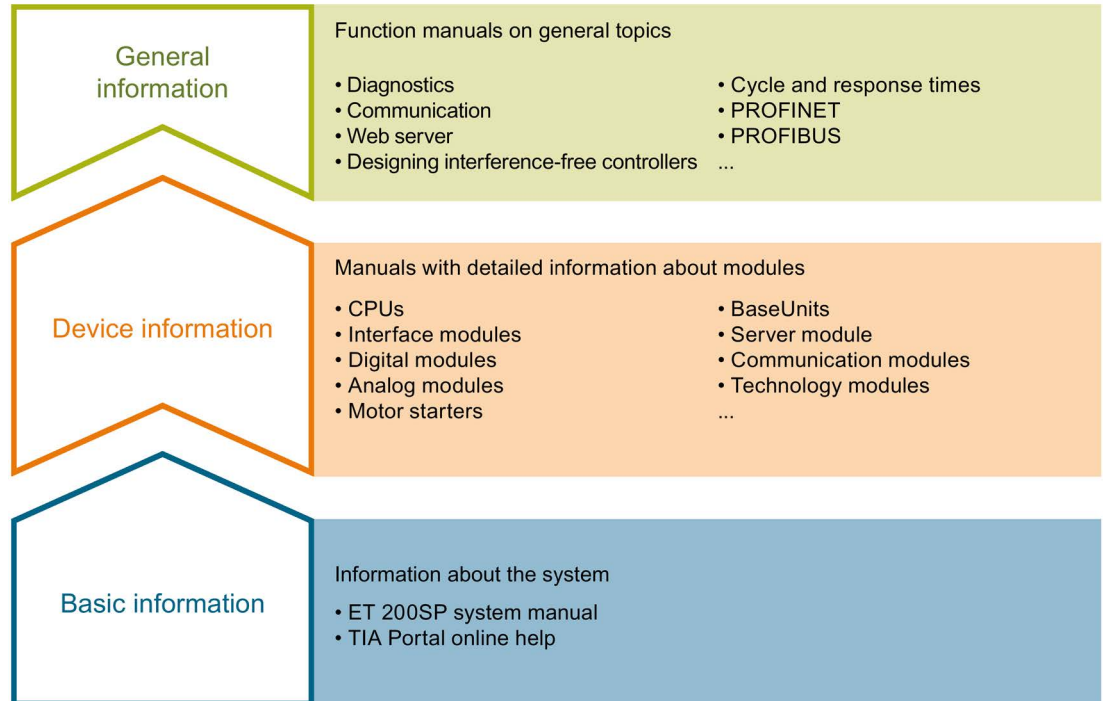

Basic information

The system manual describes in detail the configuration, installation, wiring and commissioning of the SIMATIC ET 200SP. distributed I/O system. The STEP 7 online help supports you in the configuration and programming.

Device information

Product manuals contain a compact description of the module-specific information, such as properties, wiring diagrams, characteristics and technical specifications.

General information

The function manuals contain detailed descriptions on general topics regarding the SIMATIC ET 200SP distributed I/O system, e.g. diagnostics, communication, Web server, motion control and OPC UA.

You can download the documentation free of charge from the Internet (<https://support.industry.siemens.com/cs/ww/en/view/109742709>).

Changes and supplements to the manuals are documented in a Product Information.

You can download the product information free of charge from the Internet (<https://support.industry.siemens.com/cs/us/en/view/73021864>).

Manual Collection ET 200SP

The Manual Collection contains the complete documentation on the SIMATIC ET 200SP distributed I/O system gathered together in one file.

You can find the Manual Collection on the Internet (<http://support.automation.siemens.com/WW/view/en/84133942>).

"mySupport"

With "mySupport", your personal workspace, you make the most of your Industry Online Support.

In "mySupport" you can store filters, favorites and tags, request CAx data and put together your personal library in the Documentation area. Furthermore, your data is automatically filled into support requests and you always have an overview of your current requests.

You need to register once to use the full functionality of "mySupport".

You can find "mySupport" in the Internet (<https://support.industry.siemens.com/My/ww/en>).

"mySupport" - Documentation

In the Documentation area of "mySupport", you have the possibility to combine complete manuals or parts of them to make your own manual.

You can export the manual in PDF format or in an editable format.

You can find "mySupport" - Documentation in the Internet (<http://support.industry.siemens.com/My/ww/en/documentation>).

"mySupport" - CAx Data

In the CAx Data area of "mySupport", you can have access the latest product data for your CAx or CAe system.

You configure your own download package with a few clicks.

In doing so you can select:

- Product images, 2D dimension drawings, 3D models, internal circuit diagrams, EPLAN macro files
- Manuals, characteristics, operating manuals, certificates
- Product master data

You can find "mySupport" - CAx Data in the Internet (<http://support.industry.siemens.com/my/ww/en/CAxOnline>).

Application examples

The application examples support you with various tools and examples for solving your automation tasks. Solutions are shown in interplay with multiple components in the system - separated from the focus in individual products.

You can find the application examples on the Internet (<https://support.industry.siemens.com/sc/ww/en/sc/2054>).

TIA Selection Tool

With the TIA Selection Tool, you can select, configure and order devices for Totally Integrated Automation (TIA).

This tool is the successor of the SIMATIC Selection Tool and combines the known configurators for automation technology into one tool.

With the TIA Selection Tool, you can generate a complete order list from your product selection or product configuration.

You can find the TIA Selection Tool on the Internet (<http://w3.siemens.com/mcms/topics/en/simatic/tia-selection-tool>).

SIMATIC Automation Tool

You can use the SIMATIC Automation Tool to run commissioning and maintenance activities simultaneously on various SIMATIC S7 stations as a bulk operation independently of the TIA Portal.

The SIMATIC Automation Tool provides a multitude of functions:

- Scanning of a PROFINET/Ethernet network and identification of all connected CPUs
- Address assignment (IP, subnet, gateway) and station name (PROFINET device) to a CPU
- Transfer of the data and the programming device/PC time converted to UTC time to the module
- Program download to CPU
- Operating mode switchover RUN/STOP
- Localization of the CPU by means of LED flashing
- Reading out CPU error information
- Reading the CPU diagnostic buffer
- Reset to factory settings
- Updating the firmware of the CPU and connected modules

You can find the SIMATIC Automation Tool on the Internet (<https://support.industry.siemens.com/cs/ww/en/view/98161300>).

PRONETA

With SIEMENS PRONETA (PROFINET network analysis), you analyze the plant network during commissioning. PRONETA features two core functions:

- The topology overview independently scans PROFINET and all connected components.
- The IO check is a fast test of the wiring and the module configuration of a system.

You can find SIEMENS PRONETA on the Internet (<https://support.industry.siemens.com/cs/ww/en/view/67460624>).

SINETPLAN

SINETPLAN, the Siemens Network Planner, supports you in planning automation systems and networks based on PROFINET. The tool facilitates professional and predictive dimensioning of your PROFINET installation as early as in the planning stage. In addition, SINETPLAN supports you during network optimization and helps you to exploit network resources optimally and to plan reserves. This helps to prevent problems in commissioning or failures during productive operation even in advance of a planned operation. This increases the availability of the production plant and helps improve operational safety.

The advantages at a glance

- Network optimization thanks to port-specific calculation of the network load
- Increased production availability thanks to online scan and verification of existing systems
- Transparency before commissioning through importing and simulation of existing STEP 7 projects
- Efficiency through securing existing investments in the long term and optimal exploitation of resources

You can find SINETPLAN on the Internet (<https://www.siemens.com/sinetplan>).

Product overview

2.1 Properties

Article number

6ES7132-6BF01-0AA0 (number in package unit: 1 unit)

6ES7132-6BF01-2AA0 (number in package unit: 10 units)

View of the module

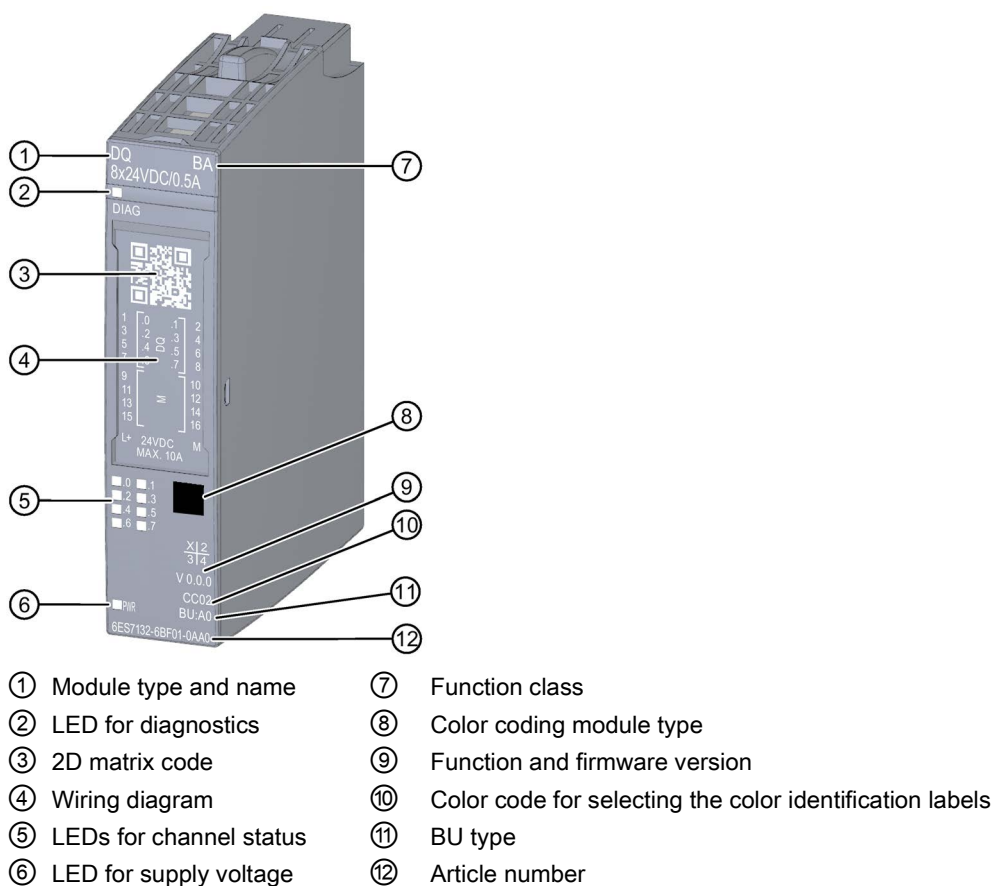

Figure 2-1 View of the module DQ 8×24VDC/0.5A BA

Properties

The module has the following technical properties:

- Digital output module with 8 outputs
- Supply voltage L+
- Output current 0.5 A (per channel)
- Source output (PNP, P-switching)
- Configurable diagnostics (per module)
- Configurable substitute values (per channel)
- Suitable for solenoid valves, DC contactors, and indicator lights
- Safety-related shutdown

The module supports the following functions:

Table 2- 1 Version dependencies of the functions

Function	HW version	FW version	STEP 7		GSD file	
			TIA Portal	V5.x	PROFINET IO	PROFIBUS DP
Identification data I&M0 to I&M3	FS01	V0.0.0 and higher	V14 or higher with HSP 0222	V5.5 SP3 or higher with HSP 0230 V7.0	X	X
Configuration in RUN	FS01	V0.0.0 and higher	V14 or higher with HSP 0222	V5.5 SP3 or higher with HSP 0230 V7.0	X	X

Accessories

The following accessories must be ordered separately:

- Labeling strips
- Color identification labels
- Reference identification label
- Shield connector

See also

You can find additional information on the accessories in the system manual Distributed I/O System ET 200SP (<http://support.automation.siemens.com/WW/view/en/58649293>).

Wiring

3.1 Wiring and block diagram

This section includes the block diagram of the DQ 8x24VDC/0.5A BA module with the terminal assignments for a 1-wire, 2-wire and 3-wire connection.

You can use and combine the different wiring options for all channels.

You can find information on wiring the BaseUnit in the system manual Distributed I/O System ET 200SP (<http://support.automation.siemens.com/WW/view/en/58649293>).

Note

The load group of the module must begin with a light-colored BaseUnit. Keep this in mind also during the configuration.

Note**Cross circuit at output**

Be aware that voltage from a cross-circuit at the output can feed L+ to modules.

Wiring: 1 and 2-wire connection of actuators

The following figure shows an example of the terminal assignment of the digital output module DQ 8x24VDC/0.5A BA on the BaseUnit BU type A0 without AUX terminals (1- and 2-wire connection).

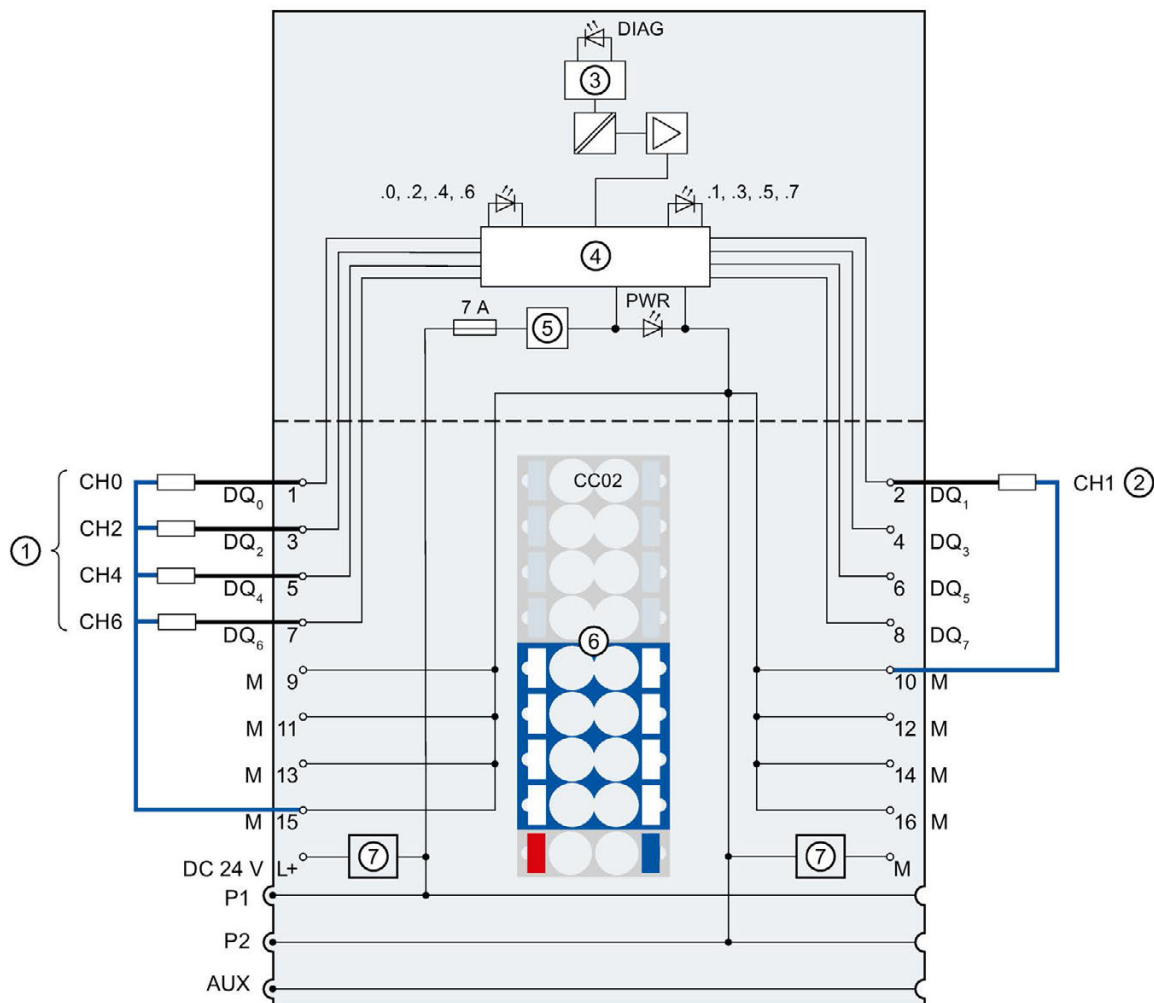

①	1-wire connection	24 V DC	Supply voltage L+ (infeed for light-colored BaseUnit only)
②	2-wire connection	M	Ground
③	Backplane bus interface	P1, P2, AUX	Internal self-assembling voltage buses Connection to left (dark-colored BaseUnit) Connection to left interrupted (light-colored BaseUnit)
④	Output electronics	DQ _n	Output signal, channel n
⑤	Polarity reversal protection	DIAG	Error or diagnostics LED (green, red)
⑥	Color-coded label with color code CC02 (optional)	.0 to .7	Channel status LED (green)
⑦	Filter connection supply voltage (only when light-colored BaseUnit is present)	PWR	Power LED (green)

Figure 3-1 Block diagram and terminal assignment for 1- and 2-wire connection of actuators

Wiring: 3-wire connection of actuators

The following figure shows an example of the terminal assignment of the digital output module DQ 8x24VDC/0.5A BA on the BaseUnit BU type A0 with AUX terminals (3-wire connection).

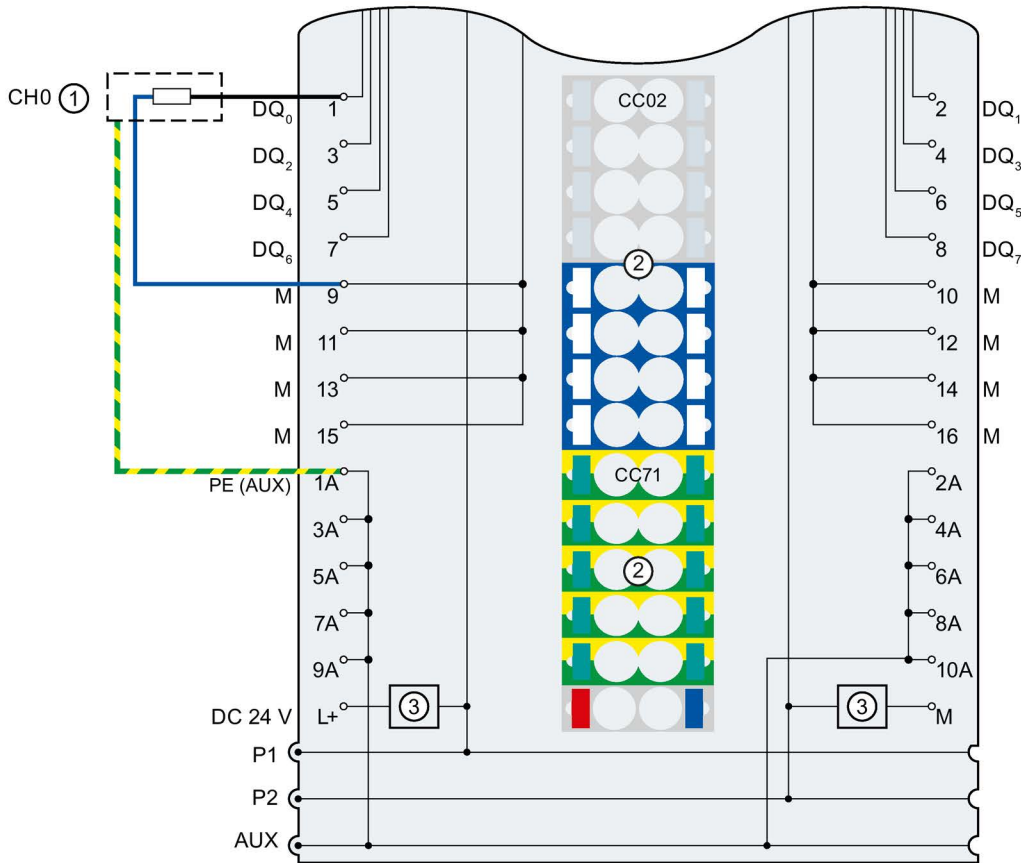

①	3-wire connection	1 A to 10 A	AUX terminals
②	Color-coded labels with color codes CC02 and CC71 (optional)	PE (AUX)	Protective conductor connection
③	Filter connection supply voltage (only when light-colored BaseUnit is present)	24 V DC	Supply voltage L+ (infeed for light-colored BaseUnit only)
DQ _n	Output signal, channel n	M	Ground
		P1, P2, AUX	Internal self-assembling voltage buses
			Connection to left (dark-colored BaseUnit)
			Connection to left interrupted (light-colored BaseUnit)

Figure 3-2 Terminal assignment for 3-wire connection of actuators

Parameters/address space

4.1 Parameters

Parameters for DQ 8x24VDC/0.5A BA

Specify the module properties with the various parameters in the course of your STEP 7 configuration. The following table lists the configurable parameters. The effective range of the configurable parameters depends on the type of configuration.

The following configurations are possible:

- Central operation with an ET 200SP CPU
- Distributed operation on PROFINET IO in an ET 200SP system
- Distributed operation with PROFIBUS DP in an ET 200SP system

When assigning parameters in the user program, use the "WRREC" instruction to transfer the parameters to the module by means of data records, see section Parameter assignment and structure of parameter data record (Page 29).

The following parameter settings are possible:

Table 4- 1 Configurable parameters and their defaults (GSD file)

Parameters	Range of values	Default	Parameter reassignment in RUN	Scope with configuration software, e.g. STEP 7 (TIA Portal)	
				GSD file PROFINET IO	GSD file PROFIBUS DP 1
Diagnostics: No supply voltage L+	<ul style="list-style-type: none"> • Disable • Enable 	Disable	Yes	Module	Module
Channel activated	<ul style="list-style-type: none"> • Disable • Enable 	Enable	Yes	Channel	Channel

4.1 Parameters

Parameters	Range of values	Default	Parameter reassignment in RUN	Scope with configuration software, e.g. STEP 7 (TIA Portal)	
				GSD file PROFINET IO	GSD file PROFIBUS DP ¹
Reaction to CPU STOP	<ul style="list-style-type: none"> • Turn off • Keep last value • Output substitute value 1 	Turn off	Yes	Channel	Module
Potential group	<ul style="list-style-type: none"> • Use potential group of the left module (module plugged into a dark-colored BaseUnit) • Enable new potential group (module plugged into light-colored BaseUnit) 	Use potential group of the left module	No	Module	Module

¹ Due to the limited number of parameters at a maximum of 244 bytes per ET 200SP station with a PROFIBUS GSD configuration, the configuration options are restricted. If required, you can assign these parameters using data record 128 as described in the "GSD file PROFINET IO" column (see table above). The parameter length of the I/O module is 16 bytes.

4.2 Explanation of the parameters

Diagnostics: No supply voltage L+

Enabling of the diagnostics for no or insufficient supply voltage L+.

Channel activated

Determines whether a channel is activated or deactivated.

Reaction to CPU STOP

Determines the behavior of the module in the event of a CPU STOP.

Potential group

A potential group consists of a group of directly adjacent I/O modules within an ET 200SP station, which are supplied via a common supply voltage.

A potential group begins with a light-colored BaseUnit through which the required voltage is supplied for all modules of the potential group. The light-colored BaseUnit interrupts the three self-assembling voltage buses P1, P2 and AUX to the left neighbor.

All additional I/O modules of this potential group are plugged into dark-colored BaseUnits. You take the potential of the self-assembling voltage buses P1, P2 and AUX from the left neighbor.

A potential group ends with the dark-colored BaseUnit, which follows a light-colored BaseUnit or server module in the station configuration.

See also

ET 200SP distributed I/O system
(<http://support.automation.siemens.com/WW/view/en/58649293>)

4.3 Address space

The module can be configured differently in STEP 7; see following table. Depending on the configuration, additional/different addresses are assigned in the process image of the inputs.

Configuration options of DQ 8x24VDC 0.5A BA

You can configure the module with STEP 7 (TIA Portal) or with a GSD file. If you configure the module using a GSD file, the configurations are available under various short designations/module names; see the table below. The following configurations are possible:

Table 4-2 Configuration options with GSD file

Configuration	Short designation/module name in the GSD file	Configuration software, e.g. with STEP 7 (TIA Portal)		
		Integrated in hardware catalog STEP 7	GSD file PROFINET IO	GSD file PROFIBUS DP
1 x 8-channel without value status	DQ 8x24VDC 0.5A BA V0.0	V14, SP1 or higher with HSP 0222	X	X

Address space of the digital output module DQ 8x24VDC 0.5A BA

The figure below shows the assignment of the address space for DQ 8x24VDC/0.5A BA

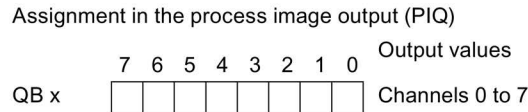

Figure 4-1 Address space of DQ 8x24VDC/0.5A BA

Interrupts/diagnostics alarms

5.1 Status and error display

LED display

DQ 8x24VDC/0.5A BA.

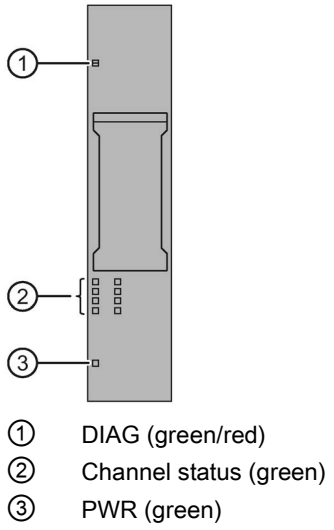





Figure 5-1 LED display

Meaning of the LEDs

The following tables show the meaning of the status and error displays. Corrective measures for diagnostics alarms can be found in section Diagnostics alarms (Page 23).



DIAG LED

Table 5- 1 Error display of the DIAG LED

DIAG LED	Meaning
 Off	Backplane bus supply of the ET 200SP not OK
 Flashes	Module parameters not assigned
 On	Module parameters assigned and no module diagnostics
 Flashes	Module diagnostics is available



Channel status LED

Table 5- 2 Status display of the channel status LED

Channel status LED	Meaning
 Off	Channel deactivated or activated and process signal = 0
 On	Channel activated and process signal = 1

PWR LED

Table 5- 3 Status display of the PWR LED

PWR LED	Meaning
 Off	Missing supply voltage L+
 On	Supply voltage L+ present

5.2 Interrupts

The DQ 8x24VDC/0.5A BA digital output module supports diagnostics interrupts.

Diagnostics interrupts

The module generates a diagnostic interrupt at the following events:

- Parameter assignment error
- Supply voltage missing

5.3 Diagnostics alarms

A diagnostics alarm is generated and the DIAG-LED flashes on the module for each diagnostics event. You can read out the diagnostics alarms, for example, in the diagnostics buffer of the CPU. You can evaluate the error codes with the user program.

Table 5- 4 Diagnostics alarms, their meaning and corrective measures

Diagnostics alarm	Error code	Meaning	Solution
Parameter assignment error	10 _H	<ul style="list-style-type: none"> • The module cannot evaluate parameters for the channel. • Incorrect parameter assignment. 	Correct the parameter assignment
Supply voltage missing	11 _H	Missing or insufficient supply voltage L+	<ul style="list-style-type: none"> • Check supply voltage L+ on the BaseUnit • Check BaseUnit type

Technical specifications

6.1 Technical specifications

Technical specifications of the DQ 8x24VDC/0.5A BA

Article number	6ES7132-6BF01-0AA0
General information	
Product type designation	DQ 8x24 VDC/0.5 A BA
Firmware version	V0.0
<ul style="list-style-type: none"> FW update possible 	No
usable BaseUnits	BU type A0
Color code for module-specific color identification plate	CC02
Product function	
<ul style="list-style-type: none"> I&M data 	Yes; I&M0 to I&M3
Engineering with	
<ul style="list-style-type: none"> STEP 7 TIA Portal configurable/integrated as of version 	V14
<ul style="list-style-type: none"> STEP 7 configurable/integrated as of version 	V5.5 SP3
<ul style="list-style-type: none"> PROFIBUS as of GSD version/GSD revision 	One GSD file each, Revision 3 and 5 and higher
<ul style="list-style-type: none"> PROFINET as of GSD version/GSD revision 	GSDML V2.3
Operating mode	
<ul style="list-style-type: none"> DQ 	Yes
<ul style="list-style-type: none"> DQ with energy-saving function 	No
<ul style="list-style-type: none"> PWM 	No
<ul style="list-style-type: none"> Oversampling 	No
<ul style="list-style-type: none"> MSO 	No
Redundancy	
<ul style="list-style-type: none"> Redundancy capability 	Yes
Supply voltage	
Rated value (DC)	24 V
permissible range, lower limit (DC)	19.2 V
permissible range, upper limit (DC)	28.8 V
Reverse polarity protection	Yes

Article number	6ES7132-6BF01-0AA0
Input current	
Current consumption, max.	45 mA; without load
Output voltage	
Rated value (DC)	24 V
Power loss	
Power loss, typ.	1 W
Address area	
Address space per module	
• Outputs	1 byte
Hardware configuration	
Automatic encoding	Yes
• Mechanical coding element	Yes
Selection of BaseUnit for connection variants	
• 1-wire connection	BU type A0
• 2-wire connection	BU type A0
• 3-wire connection	BU type A0 with AUX terminals
• 4-wire connection	BU type A0 + Potential isolation module
Digital outputs	
Type of digital output	Source output (PNP, current-sourcing)
Number of digital outputs	8
Current-sourcing	Yes
Short-circuit protection	Yes; per channel, electronic
• Response threshold, typ.	1 A
Limitation of inductive shutdown voltage to	Typ. L+ (-50 V)
Controlling a digital input	Yes
Switching capacity of the outputs	
• with resistive load, max.	0.5 A
• on lamp load, max.	5 W
Load resistance range	
• lower limit	48 Ω
• upper limit	100 kΩ
Output current	
• for signal "1" rated value	0.5 A
• for signal "1" permissible range, max.	0.5 A
• for signal "0" residual current, max.	10 μA
Output delay with resistive load	
• "0" to "1", max.	100 μs; at rated load
• "1" to "0", max.	150 μs; at rated load

Article number	6ES7132-6BF01-0AA0
Parallel switching of two outputs	
<ul style="list-style-type: none"> for uprating 	No
<ul style="list-style-type: none"> for redundant control of a load 	Yes
Switching frequency	
<ul style="list-style-type: none"> with resistive load, max. 	100 Hz
<ul style="list-style-type: none"> with inductive load, max. 	2 Hz
<ul style="list-style-type: none"> on lamp load, max. 	10 Hz
Total current of the outputs	
<ul style="list-style-type: none"> Current per channel, max. 	0.5 A
<ul style="list-style-type: none"> Current per module, max. 	4 A
Total current of the outputs (per module)	
horizontal installation	
<ul style="list-style-type: none"> up to 30 °C, max. 	4 A
<ul style="list-style-type: none"> up to 40 °C, max. 	4 A
<ul style="list-style-type: none"> up to 50 °C, max. 	4 A
<ul style="list-style-type: none"> up to 60 °C, max. 	4 A
vertical installation	
<ul style="list-style-type: none"> up to 30 °C, max. 	4 A; in all other mounting positions
<ul style="list-style-type: none"> up to 40 °C, max. 	4 A; in all other mounting positions
<ul style="list-style-type: none"> up to 50 °C, max. 	4 A; in all other mounting positions
Cable length	
<ul style="list-style-type: none"> shielded, max. 	1 000 m
<ul style="list-style-type: none"> unshielded, max. 	600 m
Isochronous mode	
Isochronous operation (application synchronized up to terminal)	No
Interrupts/diagnostics/status information	
Diagnostics function	Yes
Substitute values connectable	Yes
Alarms	
<ul style="list-style-type: none"> Diagnostic alarm 	Yes
Diagnostic messages	
<ul style="list-style-type: none"> Monitoring the supply voltage 	Yes
<ul style="list-style-type: none"> Wire-break 	No
<ul style="list-style-type: none"> Short-circuit 	No

Article number	6ES7132-6BF01-0AA0
Diagnostics indication LED	
<ul style="list-style-type: none"> • Monitoring of the supply voltage (PWR-LED) • Channel status display • for channel diagnostics • for module diagnostics 	<p>Yes; green PWR LED</p> <p>Yes; Green LED</p> <p>No</p> <p>Yes; green/red DIAG LED</p>
Potential separation	
Potential separation channels	
<ul style="list-style-type: none"> • between the channels • between the channels and backplane bus • between the channels and the power supply of the electronics 	<p>No</p> <p>Yes</p> <p>No</p>
Isolation	
Isolation tested with	707 V DC (type test)
Standards, approvals, certificates	
Suitable for safety-oriented group deactivation	Yes
Ambient conditions	
Ambient temperature during operation	
<ul style="list-style-type: none"> • horizontal installation, min. • horizontal installation, max. • vertical installation, min. • vertical installation, max. 	<p>0 °C</p> <p>60 °C</p> <p>0 °C; in all other mounting positions</p> <p>50 °C; in all other mounting positions</p>
Altitude during operation relating to sea level	
<ul style="list-style-type: none"> • Ambient air temperature-barometric pressure-altitude 	On request: Ambient temperatures lower than 0 °C (without condensation) and/or installation altitudes greater than 2 000 m
Dimensions	
Width	15 mm
Height	73 mm
Depth	58 mm
Weights	
Weight, approx.	30 g

Safety-related shutdown

Note

The digital output module DQ 8x24VDC/0.5A BA supports safety-related shutdown in connection with a fail-safe power module F-PM-E 24VDC/8A PPM ST:

- SIL according to IEC 61508: 2
 - Highest attainable safety class in safety mode, performance level according to EN ISO 13849-1: d
-

Dimension drawing

See manual ET 200SP BaseUnits

(<http://support.automation.siemens.com/WW/view/en/59753521>)

Parameter data record

A.1 Parameter assignment and structure of the parameter data record

The data record of the module has an identical structure, regardless of whether you configure the module with PROFIBUS DP or PROFINET IO. With data record 128, you can reconfigure the module in your user program regardless of your programming. This means that you can use all the functions of the module even if you configured it via PROFIBUS-GSD.

Parameter assignment in the user program

You have the option to reconfigure the module in RUN (e.g. the response of selected channels to the CPU-STOP state can be changed in RUN without having an effect on the other channels).

Changing parameters in RUN

The "WRREC" instruction is used to transfer the parameters to the module using data record 128. The parameters set in STEP 7 are not changed in the CPU, which means that the parameters set in STEP 7 will be valid again after a restart.

Output parameter STATUS

If errors occur when transferring parameters with the "WRREC" instruction, the module continues operation with the previous parameter assignment. The STATUS output parameter contains a corresponding error code.

You will find a description of the "WRREC" instruction and the error codes in the STEP 7 online help.

Structure of data record 128

Note

Channel 0 includes the diagnostics enable for the entire module.

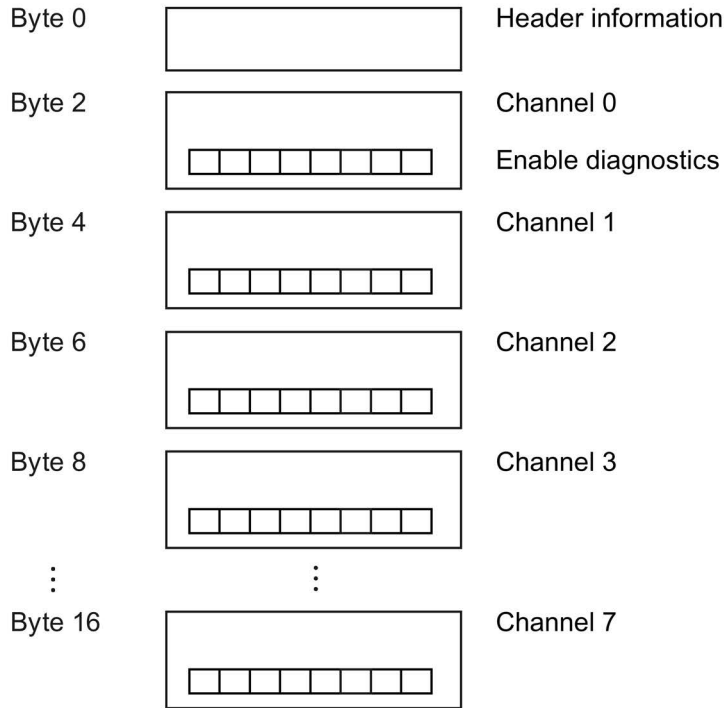

Figure A-1 Structure of data record 128

Header information

The figure below shows the structure of the header information.

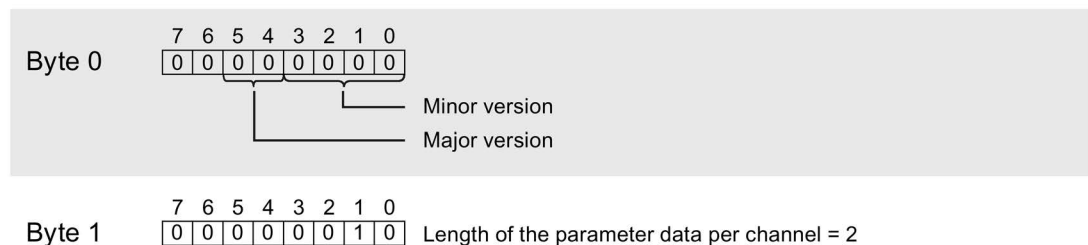

Figure A-2 Header information

Parameters

The figure below shows the structure of the parameters for channels 0 to 7.

You enable a parameter by setting the corresponding bit to "1".

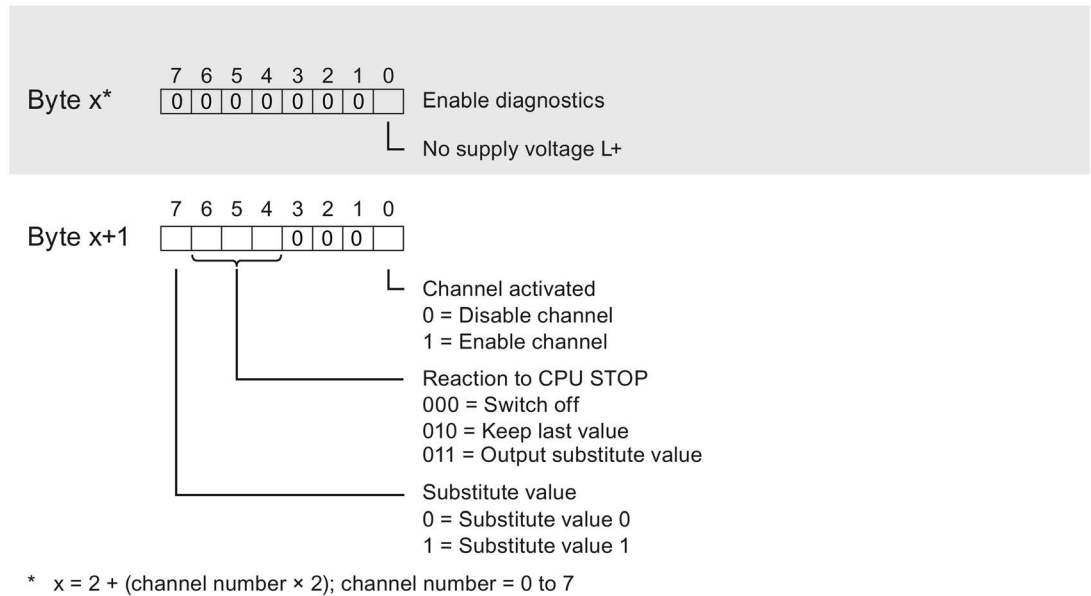

Figure A-3 Structure byte x to x+1 for the channels 0 to 7

Error transferring the data record

The module always checks all the values of the transferred data record. Only if all the values were transferred without errors does the module apply the values from the data record.

The WRREC instruction for writing data records returns corresponding error codes when errors occur in the STATUS parameter. (See also the description of the "STATUS" parameter in the STEP 7 online help).

The following table shows the module-specific error codes and their meaning for the parameter data record 128.

Error code in STATUS parameter (hexadecimal)				Meaning	Solution
Byte 0	Byte 1	Byte 2	Byte 3		
DF	80	B0	xx	Number of the data record unknown.	Enter a valid number for the data record.
DF	80	B1	xx	Length of the data record incorrect.	Enter a valid value for the data record length.
DF	80	B2	xx	Slot invalid or cannot be accessed.	<ul style="list-style-type: none"> • Check the station whether the module is plugged or drawn. • Check the assigned values for the parameters of the WRREC instruction.
DF	80	E0	xx	Wrong version or error in the header information.	Correct the version, length and number of parameter blocks.
DF	80	E1	06	Invalid coding for substitute value behavior.	Check the parameters of the module.