

Power contactor, AC-3 150 A, 75 kW / 400 V AC (50-60 Hz) / DC operation 440-480 V UC Auxiliary contacts 2 NO + 2 NC 3-pole, Size S6 Busbar connections Drive: conventional screw terminal



Product brand name	SIRIUS
Product designation	Power contactor
Product type designation	3RT1

General technical data	
Size of contactor	S6
Product extension	
<ul style="list-style-type: none"> function module for communication 	No
<ul style="list-style-type: none"> Auxiliary switch 	Yes
Surge voltage resistance	
<ul style="list-style-type: none"> of main circuit rated value 	8 kV
<ul style="list-style-type: none"> of auxiliary circuit rated value 	6 kV
maximum permissible voltage for safe isolation	
<ul style="list-style-type: none"> between coil and main contacts acc. to EN 60947-1 	690 V
Protection class IP	
<ul style="list-style-type: none"> on the front 	IP00; IP20 on the front with cover / box terminal
<ul style="list-style-type: none"> of the terminal 	IP00
Shock resistance at rectangular impulse	
<ul style="list-style-type: none"> at AC 	8,5g / 5 ms, 4,2g / 10 ms

<ul style="list-style-type: none"> • at DC 	8,5g / 5 ms, 4,2g / 10 ms
Shock resistance with sine pulse	
<ul style="list-style-type: none"> • at AC 	13,4g / 5 ms, 6,5g / 10 ms
<ul style="list-style-type: none"> • at DC 	13,4g / 5 ms, 6,5g / 10 ms
Mechanical service life (switching cycles)	
<ul style="list-style-type: none"> • of contactor typical 	10 000 000
<ul style="list-style-type: none"> • of the contactor with added electronics-compatible auxiliary switch block typical 	5 000 000
<ul style="list-style-type: none"> • of the contactor with added auxiliary switch block typical 	10 000 000
Reference code acc. to DIN 40719 extended according to IEC 204-2 acc. to IEC 750	K
Reference code acc. to DIN EN 81346-2	Q

Ambient conditions

Installation altitude at height above sea level	
<ul style="list-style-type: none"> • maximum 	2 000 m
Ambient temperature	
<ul style="list-style-type: none"> • during operation 	-25 ... +60 °C
<ul style="list-style-type: none"> • during storage 	-55 ... +80 °C

Main circuit

Number of poles for main current circuit	3
Number of NO contacts for main contacts	3
Operating voltage	
<ul style="list-style-type: none"> • at AC-3 rated value maximum 	1 000 V
Operating current	
<ul style="list-style-type: none"> • at AC-1 at 400 V <ul style="list-style-type: none"> — at ambient temperature 40 °C rated value 	185 A
<ul style="list-style-type: none"> • at AC-1 <ul style="list-style-type: none"> — up to 690 V at ambient temperature 40 °C rated value — up to 690 V at ambient temperature 60 °C rated value — up to 1000 V at ambient temperature 40 °C rated value — up to 1000 V at ambient temperature 60 °C rated value 	185 A 160 A 90 A 90 A
<ul style="list-style-type: none"> • at AC-2 at 400 V rated value 	150 A
<ul style="list-style-type: none"> • at AC-3 <ul style="list-style-type: none"> — at 400 V rated value — at 500 V rated value — at 690 V rated value — at 1000 V rated value 	150 A 150 A 150 A 65 A

<ul style="list-style-type: none"> • at AC-4 at 400 V rated value 	132 A
Connectable conductor cross-section in main circuit at AC-1	
<ul style="list-style-type: none"> • at 60 °C minimum permissible 	70 mm ²
<ul style="list-style-type: none"> • at 40 °C minimum permissible 	95 mm ²
Operating current for approx. 200000 operating cycles at AC-4	
<ul style="list-style-type: none"> • at 400 V rated value 	68 A
<ul style="list-style-type: none"> • at 690 V rated value 	57 A
Operating current	
<ul style="list-style-type: none"> • at 1 current path at DC-1 <ul style="list-style-type: none"> — at 24 V rated value — at 110 V rated value — at 220 V rated value — at 440 V rated value — at 600 V rated value 	160 A 18 A 3.4 A 0.8 A 0.5 A
<ul style="list-style-type: none"> • with 2 current paths in series at DC-1 <ul style="list-style-type: none"> — at 24 V rated value — at 110 V rated value — at 220 V rated value — at 440 V rated value — at 600 V rated value 	160 A 160 A 20 A 3.2 A 1.6 A
<ul style="list-style-type: none"> • with 3 current paths in series at DC-1 <ul style="list-style-type: none"> — at 24 V rated value — at 110 V rated value — at 220 V rated value — at 440 V rated value — at 600 V rated value 	160 A 160 A 160 A 11.5 A 4 A
Operating current	
<ul style="list-style-type: none"> • at 1 current path at DC-3 at DC-5 <ul style="list-style-type: none"> — at 24 V rated value — at 110 V rated value — at 220 V rated value — at 440 V rated value — at 600 V rated value 	160 A 2.5 A 0.6 A 0.17 A 0.12 A
<ul style="list-style-type: none"> • with 2 current paths in series at DC-3 at DC-5 <ul style="list-style-type: none"> — at 24 V rated value — at 110 V rated value — at 220 V rated value — at 440 V rated value — at 600 V rated value 	160 A 160 A 2.5 A 0.65 A 0.37 A
<ul style="list-style-type: none"> • with 3 current paths in series at DC-3 at DC-5 	

— at 24 V rated value	160 A
— at 110 V rated value	160 A
— at 220 V rated value	160 A
— at 440 V rated value	1.4 A
— at 600 V rated value	0.75 A
Operating power	
• at AC-1	
— at 230 V at 60 °C rated value	60 kW
— at 400 V rated value	105 kW
— at 400 V at 60 °C rated value	105 kW
— at 690 V rated value	181 kW
— at 690 V at 60 °C rated value	181 kW
— at 1000 V at 60 °C rated value	148 kW
• at AC-2 at 400 V rated value	75 kW
• at AC-3	
— at 230 V rated value	45 kW
— at 400 V rated value	75 kW
— at 500 V rated value	90 kW
— at 690 V rated value	132 kW
— at 1000 V rated value	90 kW
Operating power for approx. 200000 operating cycles at AC-4	
• at 400 V rated value	38 kW
• at 690 V rated value	55 kW
Thermal short-time current limited to 10 s	1 300 A
Power loss [W] at AC-3 at 400 V for rated value of the operating current per conductor	9 W
No-load switching frequency	
• at AC	2 000 1/h
• at DC	2 000 1/h
Operating frequency	
• at AC-1 maximum	800 1/h
• at AC-2 maximum	300 1/h
• at AC-3 maximum	750 1/h
• at AC-4 maximum	130 1/h
Control circuit/ Control	
Type of voltage of the control supply voltage	AC/DC
Control supply voltage at AC	
• at 50 Hz rated value	440 ... 480 V
• at 60 Hz rated value	440 ... 480 V
Control supply voltage at DC	
• rated value	440 ... 480 V

Operating range factor control supply voltage rated value of magnet coil at DC	
• initial value	0.8
• Full-scale value	1.1
Operating range factor control supply voltage rated value of magnet coil at AC	
• at 50 Hz	0.8 ... 1.1
• at 60 Hz	0.8 ... 1.1
Design of the surge suppressor	with varistor
Apparent pick-up power of magnet coil at AC	
• at 50 Hz	300 V·A
Inductive power factor with closing power of the coil	
• at 50 Hz	0.9
Apparent holding power of magnet coil at AC	
• at 50 Hz	5.8 V·A
Inductive power factor with the holding power of the coil	
• at 50 Hz	0.8
Closing power of magnet coil at DC	360 W
Holding power of magnet coil at DC	5.2 W
Closing delay	
• at AC	20 ... 95 ms
• at DC	20 ... 95 ms
Opening delay	
• at AC	40 ... 60 ms
• at DC	40 ... 60 ms
Arcing time	10 ... 15 ms
Control version of the switch operating mechanism	Standard A1 - A2

Auxiliary circuit

Number of NC contacts for auxiliary contacts	
• instantaneous contact	2
Number of NO contacts for auxiliary contacts	
• instantaneous contact	2
Operating current at AC-12 maximum	10 A
Operating current at AC-15	
• at 230 V rated value	6 A
• at 400 V rated value	3 A
• at 500 V rated value	2 A
• at 690 V rated value	1 A
Operating current at DC-12	
• at 24 V rated value	10 A
• at 48 V rated value	6 A

<ul style="list-style-type: none"> • at 60 V rated value • at 110 V rated value • at 125 V rated value • at 220 V rated value • at 600 V rated value 	6 A 3 A 2 A 1 A 0.15 A
Operating current at DC-13	
<ul style="list-style-type: none"> • at 24 V rated value • at 48 V rated value • at 60 V rated value • at 110 V rated value • at 125 V rated value • at 220 V rated value • at 600 V rated value 	10 A 2 A 2 A 1 A 0.9 A 0.3 A 0.1 A
Contact reliability of auxiliary contacts	1 faulty switching per 100 million (17 V, 1 mA)

UL/CSA ratings

Full-load current (FLA) for three-phase AC motor	
<ul style="list-style-type: none"> • at 480 V rated value • at 600 V rated value 	156 A 144 A
Yielded mechanical performance [hp]	
<ul style="list-style-type: none"> • for single-phase AC motor <ul style="list-style-type: none"> — at 230 V rated value • for three-phase AC motor <ul style="list-style-type: none"> — at 200/208 V rated value — at 220/230 V rated value — at 460/480 V rated value — at 575/600 V rated value 	30 hp 50 hp 60 hp 125 hp 150 hp
Contact rating of auxiliary contacts according to UL	A600 / Q600

Short-circuit protection

Design of the fuse link	
<ul style="list-style-type: none"> • for short-circuit protection of the main circuit <ul style="list-style-type: none"> — with type of coordination 1 required — with type of assignment 2 required • for short-circuit protection of the auxiliary switch required 	gG: 355 A (690 V, 100 kA) gG: 315 A (690 V, 100 kA), aM: 200 A (690 V, 50 kA), BS88: 315 A (415 V, 50 kA) gG: 10 A (500 V, 1 kA)

Installation/ mounting/ dimensions

Mounting position	with vertical mounting surface +/-90° rotatable, with vertical mounting surface +/- 22.5° tiltable to the front and back
Mounting type	screw fixing
<ul style="list-style-type: none"> • Side-by-side mounting 	Yes
Height	172 mm

Width	120 mm
Depth	170 mm
Required spacing	
<ul style="list-style-type: none"> • with side-by-side mounting <ul style="list-style-type: none"> — forwards 20 mm — upwards 10 mm — downwards 10 mm — at the side 0 mm • for grounded parts <ul style="list-style-type: none"> — forwards 20 mm — upwards 10 mm — at the side 10 mm — downwards 10 mm • for live parts <ul style="list-style-type: none"> — forwards 20 mm — upwards 10 mm — downwards 10 mm — at the side 10 mm 	

Connections/Terminals



Type of electrical connection	
<ul style="list-style-type: none"> • for main current circuit • for auxiliary and control current circuit 	<p>Connection bar</p> <p>screw-type terminals</p>
Type of connectable conductor cross-sections	
<ul style="list-style-type: none"> • at AWG conductors for main contacts 	4 ... 250 kcmil
Connectable conductor cross-section for main contacts	
<ul style="list-style-type: none"> • stranded 	25 ... 120 mm ²
Connectable conductor cross-section for auxiliary contacts	
<ul style="list-style-type: none"> • single or multi-stranded • finely stranded with core end processing 	<p>0.5 ... 4 mm²</p> <p>0.5 ... 2.5 mm²</p>
Type of connectable conductor cross-sections	
<ul style="list-style-type: none"> • for auxiliary contacts <ul style="list-style-type: none"> — solid — single or multi-stranded — finely stranded with core end processing • at AWG conductors for auxiliary contacts 	<p>2x (0.5 ... 1.5 mm²), 2x (0.75 ... 2.5 mm²), max. 2x (0.75 ... 4 mm²)</p> <p>2x (0,5 ... 1,5 mm²), 2x (0,75 ... 2,5 mm²), max. 2x (0,75 ... 4 mm²)</p> <p>2x (0.5 ... 1.5 mm²), 2x (0.75 ... 2.5 mm²)</p> <p>2x (20 ... 16), 2x (18 ... 14), 1x 12</p>
AWG number as coded connectable conductor cross section	
<ul style="list-style-type: none"> • for auxiliary contacts 	18 ... 14

Safety related data

B10 value	1 000 000
<ul style="list-style-type: none"> with high demand rate acc. to SN 31920 	
Product function	Yes
<ul style="list-style-type: none"> Mirror contact acc. to IEC 60947-4-1 positively driven operation acc. to IEC 60947-5-1 	No
Protection against electrical shock	finger-safe when touched vertically from front acc. to IEC 60529

Certificates/approvals

General Product Approval	Functional Safety/Safety of Machinery	Declaration of Conformity
 CCC	 UL	 EG-Konf.
 CSA	 EAC	Type Examination Certificate

Test Certificates	Marine / Shipping	other
Type Test Certificates/Test Report	 ABS	Confirmation
Special Test Certificate	 RMRS	 DNV-GL

other
Miscellaneous

Further information

- Information- and Downloadcenter (Catalogs, Brochures,...)**
<http://www.siemens.com/industrial-controls/catalogs>
- Industry Mall (Online ordering system)**
<https://mall.industry.siemens.com/mall/en/en/Catalog/product?mlfb=3RT1055-6AR36>
- Cax online generator**
<http://support.automation.siemens.com/WW/CAXorder/default.aspx?lang=en&mlfb=3RT1055-6AR36>
- Service&Support (Manuals, Certificates, Characteristics, FAQs,...)**
<https://support.industry.siemens.com/cs/ww/en/ps/3RT1055-6AR36>
- Image database (product images, 2D dimension drawings, 3D models, device circuit diagrams, EPLAN macros, ...)**
http://www.automation.siemens.com/bilddb/cax_de.aspx?mlfb=3RT1055-6AR36&lang=en
- Characteristic: Tripping characteristics, I²t, Let-through current**
<https://support.industry.siemens.com/cs/ww/en/ps/3RT1055-6AR36/char>
- Further characteristics (e.g. electrical endurance, switching frequency)**
<http://www.automation.siemens.com/bilddb/index.aspx?view=Search&mlfb=3RT1055-6AR36&objecttype=14&gridview=view1>

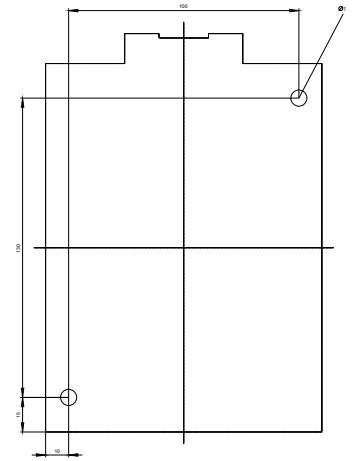
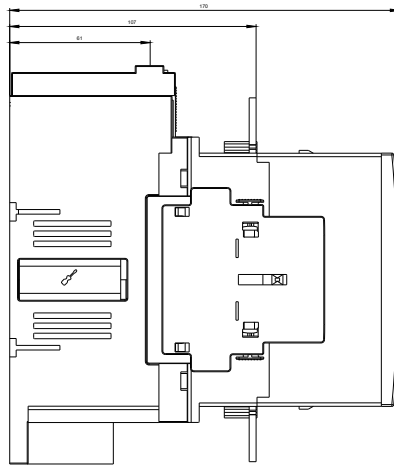
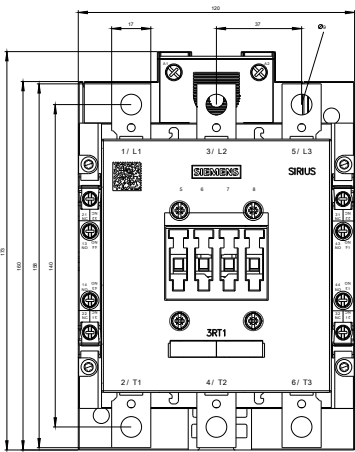

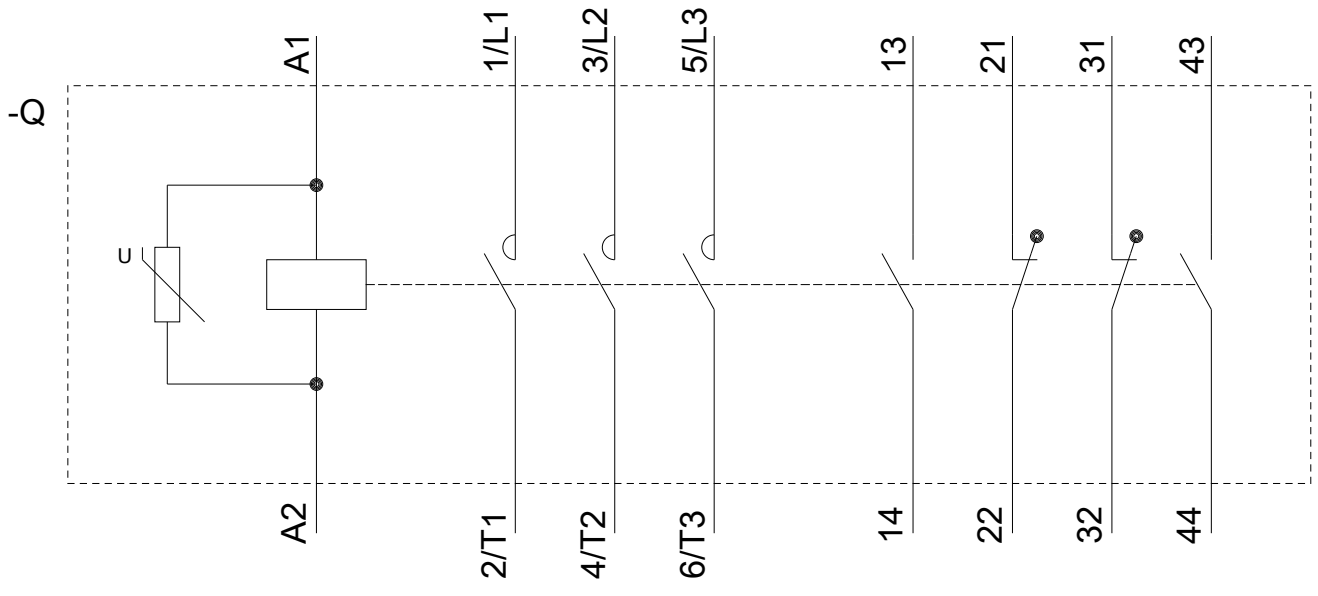

last modified:

01/20/2019