

COUPLING LINK FOR MOUNTING ONTO
AC,DC,AC/DC CONTACTORS 3RT2 S00-S3, 24V DC
CONTROL SCREW CONNECTION



Figure similar

| General technical data: | | |
|--|----|-----------------|
| product brandname | | SIRIUS |
| Size of contactor | | S00, S0, S2, S3 |
| Protection class IP on the front | | IP20 |
| Degree of pollution | | 3 |
| Product component protective wiring | | Yes |
| Ambient temperature | | |
| • during storage | °C | -40 ... +80 |
| • during operation | °C | -25 ... +60 |
| Insulation voltage rated value | V | 300 |
| Control circuit/ Control: | | |
| Type of voltage of the control supply voltage | | DC |
| Control supply voltage 1 | | |
| • at DC | | |
| — rated value | V | 24 |
| Operating range factor control supply voltage rated value of magnet coil | | |

- at DC

0.7 ... 1.25

Auxiliary circuit:

| | | |
|---|---------------------------------|-------------------------------------|
| Number of NO contacts for auxiliary contacts instantaneous contact | | 1 |
| Operating current of auxiliary contacts | | |
| <ul style="list-style-type: none"> • at AC-12 <ul style="list-style-type: none"> — at 24 V — at 230 V • at AC-15 <ul style="list-style-type: none"> — at 24 V — at 230 V • at DC-13 <ul style="list-style-type: none"> — at 24 V — at 110 V — at 220 V | A A A A A A A | 6 6 3 3 1 0.2 0.1 |





Installation/ mounting/ dimensions:

| | | |
|--------------------------|----|-----------------|
| Mounting position | | any |
| Mounting type | | direct mounting |
| Width | mm | 45 |
| Height | mm | 35 |
| Depth | mm | 50 |

Connections/ Terminals:

| | | |
|--|--|--|
| Type of connectable conductor cross-sections | | |
| <ul style="list-style-type: none"> • for auxiliary contacts <ul style="list-style-type: none"> — solid — finely stranded — with core end processing | | 2x (0.5 ... 1.5 mm ²), 2x (0.75 ... 2.5 mm ²) 2x (0.5 ... 1.5 mm ²) |

Certificates/ approvals:

| General Product Approval | | | Declaration of Conformity | Test Certificates | Shipping Approval |
|--|---|---|---|--|--|
|  CSA |  UL |  |  EG-Konf. | Type Test Certificates/Test Report |  ABS |

| Shipping Approval | | | | | other |
|---|---|--|--|---|------------------------------|
|  BUREAU VERITAS |  GL |  LRS |  PRS |  RMRS | Confirmation |

| other |
|--|
|  VDE |

Further information

Information- and Downloadcenter (Catalogs, Brochures,...)

<http://www.siemens.com/industrial-controls/catalogs>

Industry Mall (Online ordering system)

<http://www.siemens.com/industrymall>

Cax online generator

<http://support.automation.siemens.com/WW/CAXorder/default.aspx?lang=en&mlfb=3RH2914-1GP11>

Service&Support (Manuals, Certificates, Characteristics, FAQs,...)

<https://support.industry.siemens.com/cs/ww/en/ps/3RH2914-1GP11>

Image database (product images, 2D dimension drawings, 3D models, device circuit diagrams, EPLAN macros, ...)

http://www.automation.siemens.com/bilddb/cax_de.aspx?mlfb=3RH2914-1GP11&lang=en

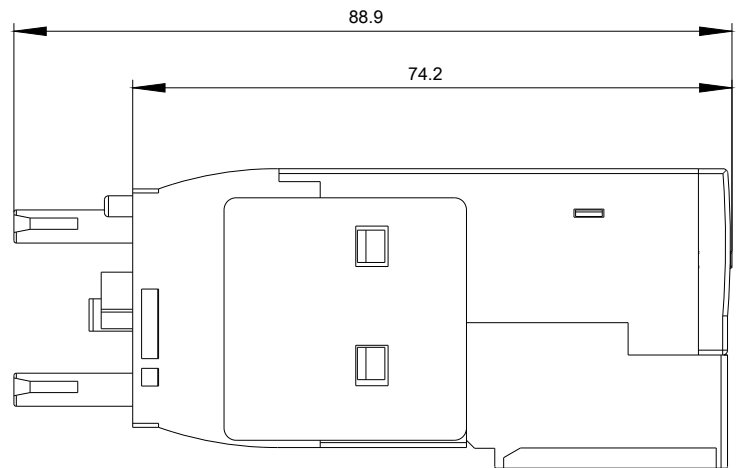
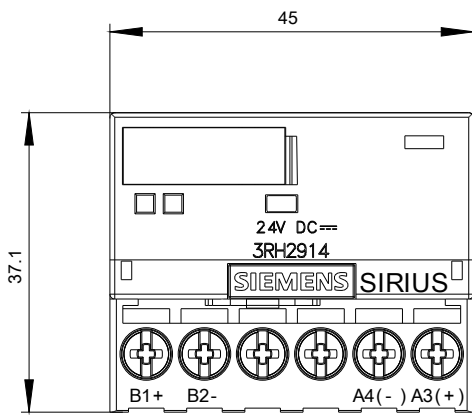

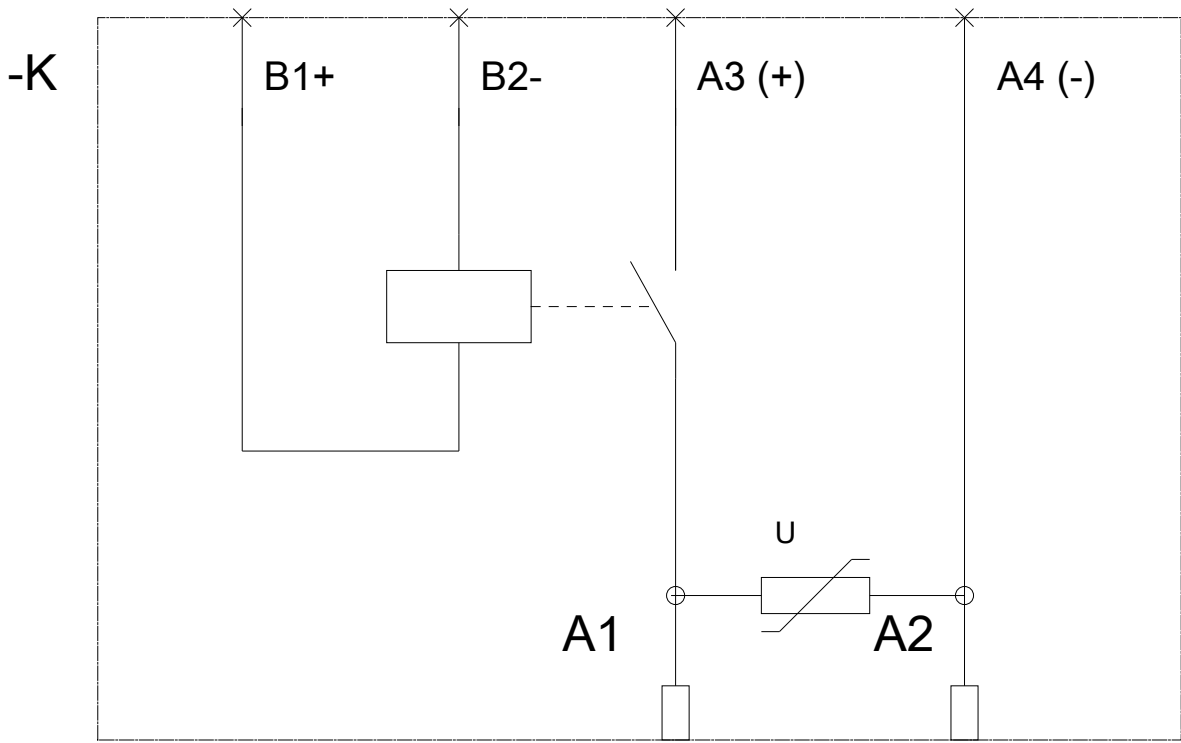

last modified:

08/26/2017