

back view

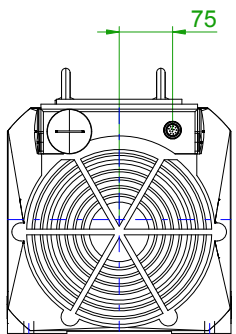

front view

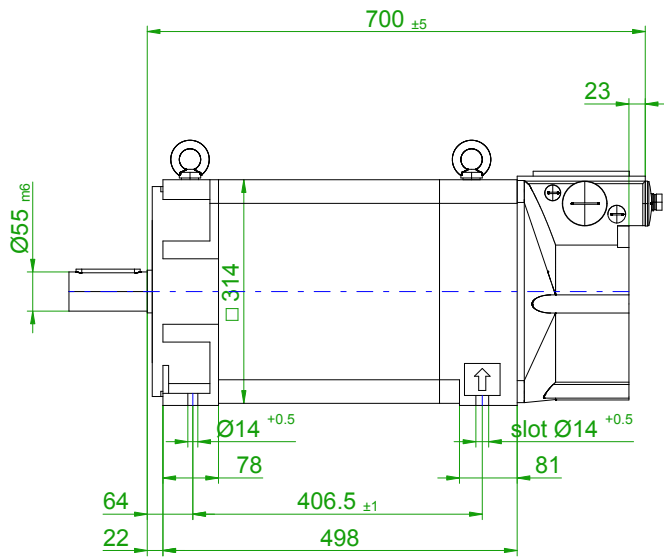
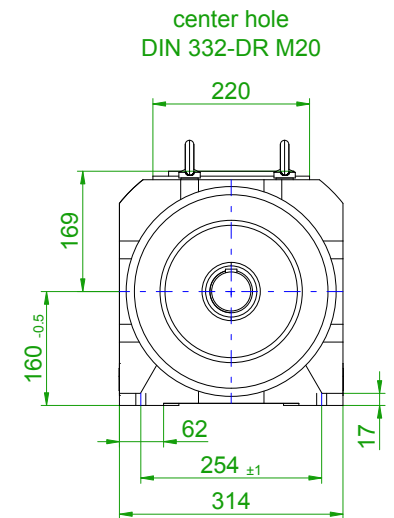

version with featherkey

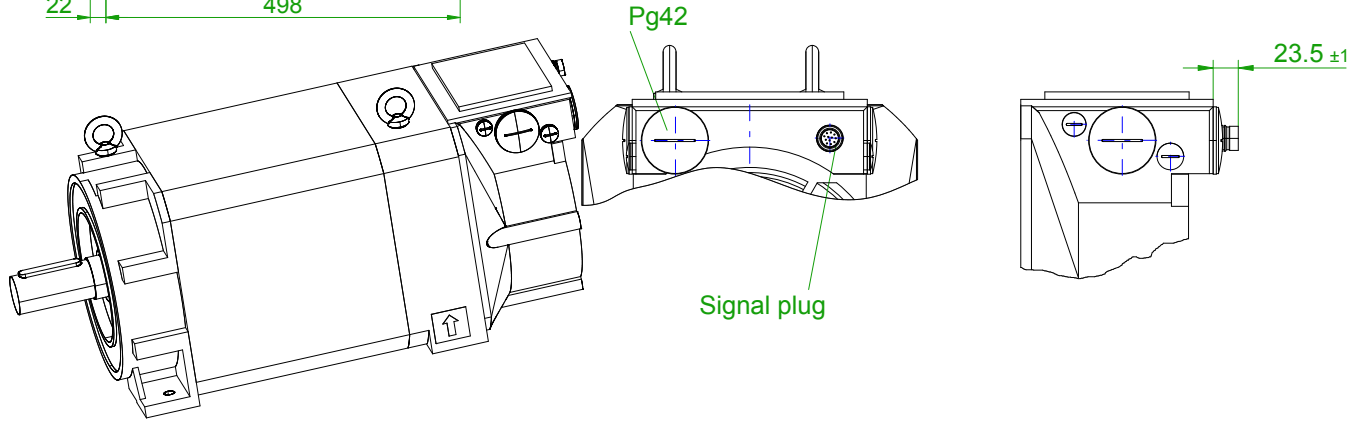
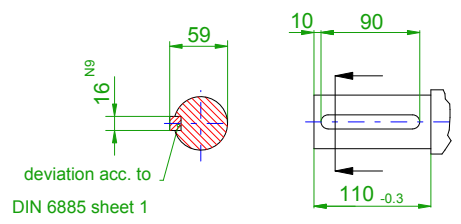

shaft acc. to DIN 42955-R

type of construction IM B3

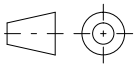
		SIEMENS	
Einheit / unit: mm		Asynchron-Servomotor Asynchronous Servo Motor:	1PH7167-2HF20-0BB3
nicht tolerierte Maße / not toleranced dimensions: ±1		Optionen / options:	
Maßstab / scale: ohne / without		Gewicht / mass:	225.5 kg
CAD CREATOR 2.2 (WWW-Version V02.20.00.00)		Bemerkung / notice:	
		Druckdatum / print date:	09.11.2017