

Part Number Keys	S2
M12 (eurofast®)	S4
M8 (picofast®)	S44
7/8" (minifast®)	S54
1/2" (microfast®)	S68
Accessories	S72

Features

- Products for M12 Eurofast, M8 Picofast, 7/8" Minifast and 1/2 Microfast
- Consolidate up to 16 I/O signals
- AC or DC options
- PNP LED, NPN LED and non-LED offerings
- Multiple housing styles and materials

multibox®

Junction Box Connectivity Products

M12 Eurofast® Standard and Low Profile Junction Box Part Number Keys

Part Number Keys are to assist in IDENTIFICATION ONLY. Consult factory for catalog items not identified.

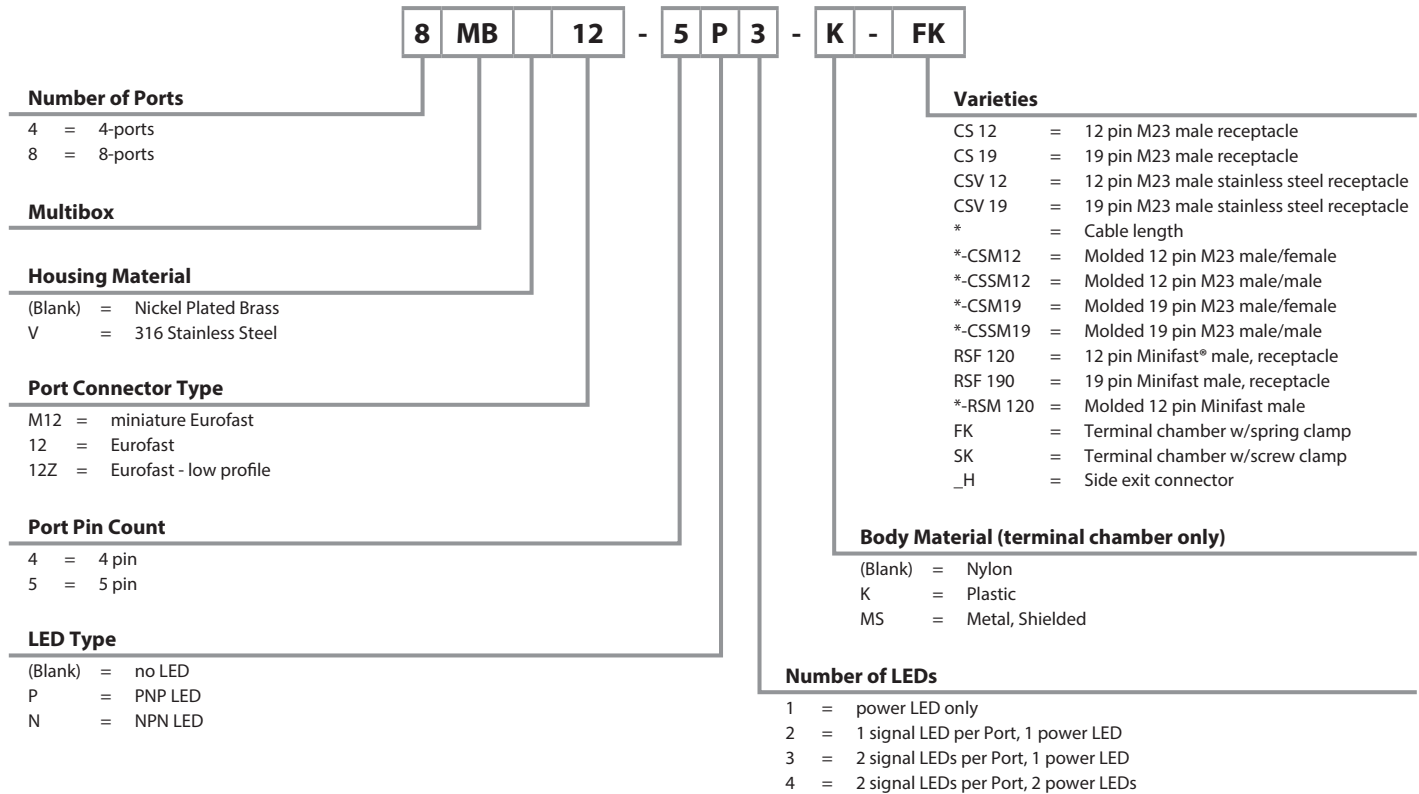
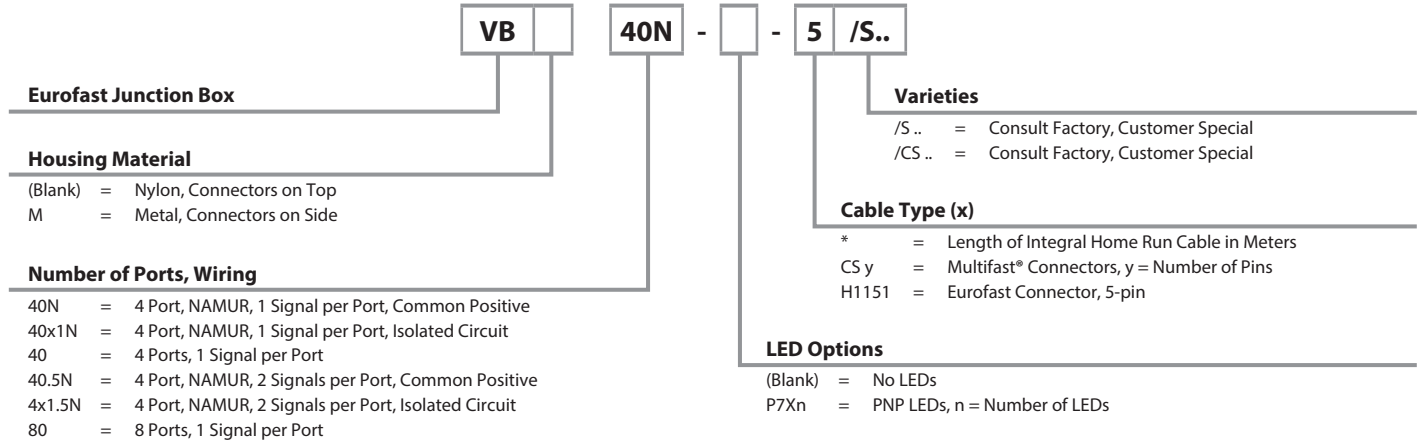

Junction Box Connectivity Products

Multibox® Eurofast® Low Profile Junction Boxes, 8-Port

- Single Input/Output per Port
- Rugged Plastic Housing
- Available with or without LEDs
- M23 Quick Disconnect or Integral Home Run Cable
- Threaded M12 Connection



8-Port, 1 Signal per Port, 10-30 VDC

Application	Specifications	Pinout		No LEDs	PNP LED	NPN LED		
8-port J-box 1 signal per port Integral cable	2 A/signal, 9 A total Yellow PVC cable 11/18 AWG, foil shield and 20 AWG drain with PUR cable, add /S90	<u>Function</u> +V -V Ground Port 1 Port 2 Port 3	<u>Color</u> BN BU GN / YE WH GN YE	<u>Function</u> Port 4 Port 5 Port 6 Port 7 Port 8	<u>Color</u> GY PK RD BK VT	8MB12Z-4-*	8MB12Z-4P2-*	8MB12Z-4N2-*
8-port J-box 1 signal per port Multifast® connector	2 A/signal, 9 A total 12-pin Multifast connector 11 conductors. Mates with CKCM 12-11-*	<u>Function</u> +V -V Ground Port 1 Port 2 Port 3	<u>Pin / Color</u> 11 / BN 10 / BU 12 / GN / YE 1 / WH 2 / GN 3 / YE	<u>Function</u> Port 4 Port 5 Port 6 Port 7 Port 8	<u>Pin / Color</u> 4 / GY 5 / PK 6 / RD 7 / BK 8 / VT	8MB12Z-4-CS12	8MB12Z-4P2-CS12	8MB12Z-4N2-CS12
8-port J-box 1 signal per port Multifast, side exit connector	2 A/signal, 9 A total 12-pin Multifast connector 11 conductors. Mates with CKCM 12-11-*	<u>Function</u> +V -V Ground Port 1 Port 2 Port 3	<u>Pin / Color</u> 11 / BN 10 / BU 12 / GN / YE 1 / WH 2 / GN 3 / YE	<u>Function</u> Port 4 Port 5 Port 6 Port 7 Port 8	<u>Pin / Color</u> 4 / GY 5 / PK 6 / RD 7 / BK 8 / VT	8MB12Z-4-CS12H	8MB12Z-4P2-CS12H	8MB12Z-4N2-CS12H

* Cable length in meters.

We reserve the right to make technical alterations without prior notice.

Functional Wiring Diagrams

(PNP LED Version)
1 Signal per Port

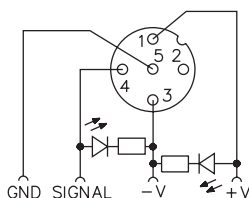

(No LED Version)
1 Signal per Port

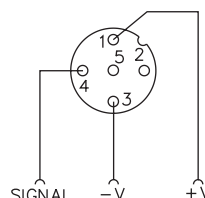

Multibox® Eurofast® Low Profile Junction Boxes, 8-Port

Specifications

Housing:	Nylon	Temperature:	-40 °C to +85 °C (-40 °F to +185 °F)
Connectors:	Eurofast: Nylon or TPU	Protection:	IEC IP68, IP69K
Contacts:	Gold plated brass	Accessories:	(2) VZ 3 closure caps and a VZ 12 label kit (9 labels), included
Thread Inserts:	Nickel plated brass	Cable Length:	Standard length is nominal 5 meters. Other lengths available by request - Consult factory
Cable:	See table		

Dimensions

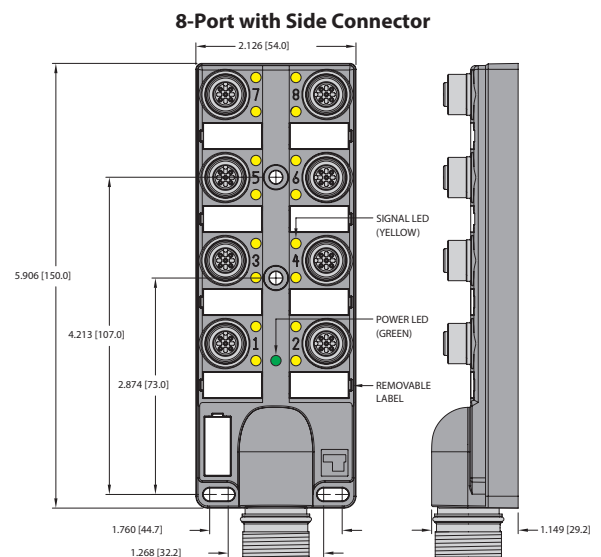
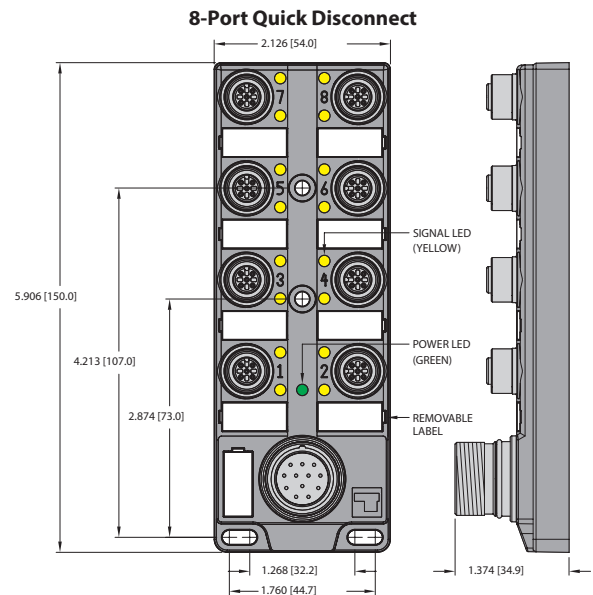
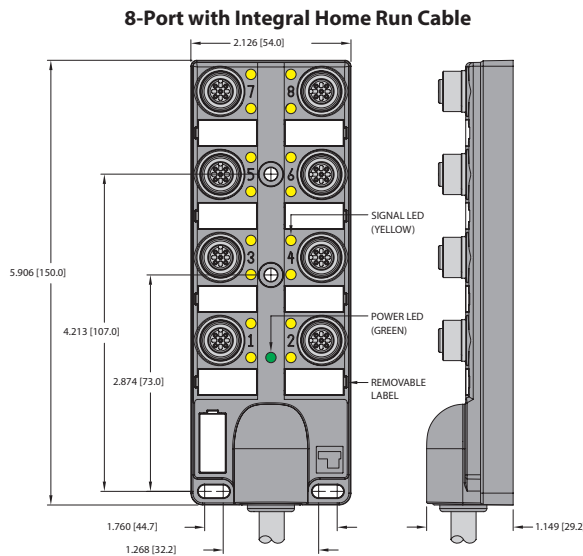

Pinout

5-Pin Eurofast	12-pin Multifast®
Female	Male

We reserve the right to make technical alterations without prior notice.

multibox®, eurofast®